

SIGN ORIENTATION PLAN

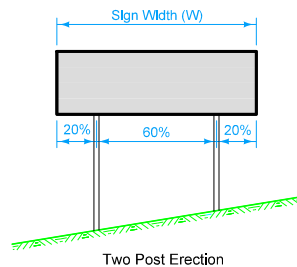

Two Post Erection

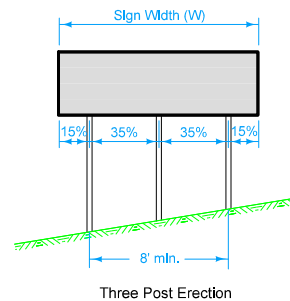

Three Post Erection

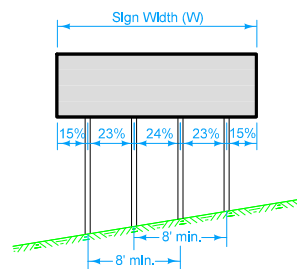

Four Post Erection
POST POSITION DETAIL

Modification of plan requirements will be permitted only as physical conditions require and are subject to the following limitations:

Provide breakaway sign posts that are a minimum length of 7'-4" plus the height of the sign, unless noted otherwise in the tabulations.

Obtain the Engineer's approval for spacing between signs less than 800 feet.

Set all signs level.

Do not modify sign location without approval of the Engineer.

Possible Contract Items:

- Install Type B Sign
- Perforated Square Steel Tube Posts
- Perforated Square Steel Tube Post Anchor (series)
- Remove and Reinstall Signs as Per Plan
- Type B Signs
- Wood Posts for Type A or B Signs, 4 in. x 6 in.
- Steel Breakaway Sign Post for Type A or B Signs
- Concrete Footing for Breakaway Sign Post

Possible Tabulations:

- 190-50
- 190-61

 STANDARD ROAD PLAN	REVISION
	2 04-19-16
	SI-102
SHEET 1 of 2	
REVISIONS: Changed 'Lane Edge Line' to 'Edge of Traveled Way', modified notes and added Possible Contract Items and Tabs. Added FOUR POST DETAIL.	
 APPROVED BY DESIGN METHODS ENGINEER	
LOCATIONS - TYPE 'B' SIGNS	

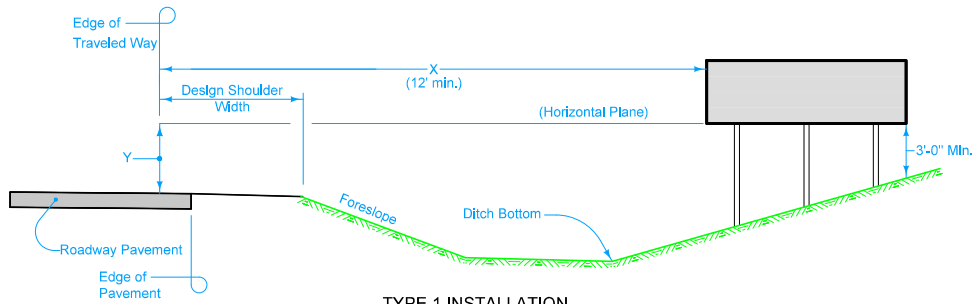

TYPE 1 INSTALLATION
(OFFSET)

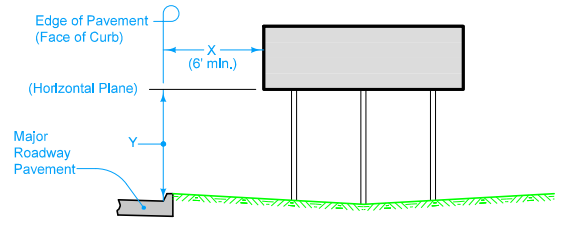

TYPE 2 INSTALLATION
(CURBED SECTION)

Details indicated are for an installation adjacent to a curbed roadway. The sign may be located on either side of the roadway, or in a gore area where curbed roadways pass on both sides, such as an urban freeway exit ramp. When located in a gore area, install where the width between curbs is no less than 12 feet plus sign width.

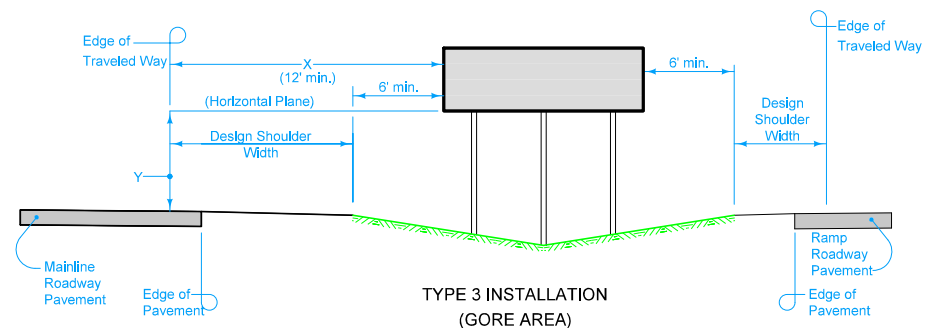

TYPE 3 INSTALLATION
(GORE AREA)

Details indicated are for an installation in a gore area where traffic on non-curbed roadways passes on both sides of the sign, such as the exit ramp for a rural type interchange.

1 Refer to the Office of Bridges and Structures' Sign Truss Standards as detailed in the contract documents. Cantilevers are special designs detailed elsewhere in the contract documents.

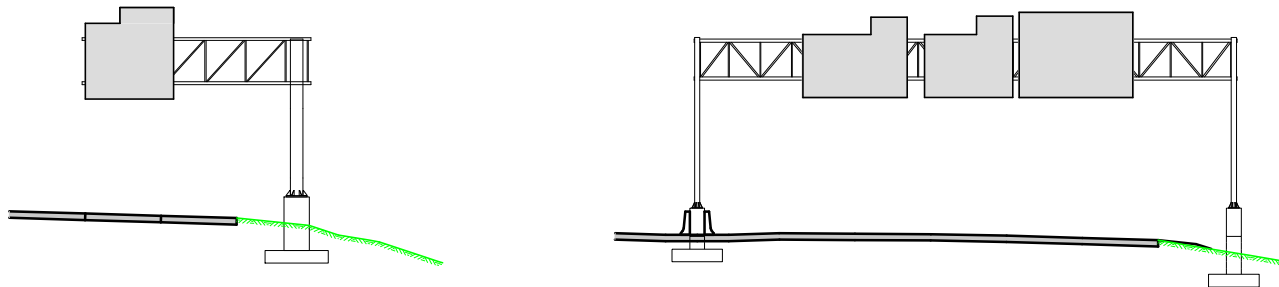

TYPE 4 INSTALLATION 1
(OVERHEAD SUPPORT STRUCTURES)

	REVISION
	2 04-19-16
	SI-102
STANDARD ROAD PLAN	SHEET 2 of 2
<small>REVISIONS: Changed 'Lane Edge Line' to 'Edge of Traveled Way', modified notes and added Possible Contract Items and Tabs. Added FOUR POST DETAIL.</small>	
<small>APPROVED BY DESIGN METHODS ENGINEER</small> <i>Brian Smith</i>	
LOCATIONS - TYPE 'B' SIGNS	