

# Steel Beam Guardrail

Design Manual  
Chapter 8  
Roadside Safety

Originally Issued: 12-20-99

Revised: 6-15-21

This section presents the information necessary to design a typical steel beam guardrail installation. Topics addressed include:

- [Parts of a steel beam guardrail installation.](#)
- [Placement requirements.](#)
- [Grading and paving requirements.](#)
- [Laying out a guardrail installation.](#)
- [Use of standard road plans.](#)
- [Unique situations.](#)

Use of this section assumes that the options discussed in Section [8A-3](#) have been considered and the decision has been made to shield the object with steel beam guardrail.

Prior to laying out any barrier installation, the specific object(s) to be shielded must be identified, and the vehicle departure path(s) must be properly established as shown in Section [8B-6](#).

Steel beam guardrail (see Figure 1), more commonly referred to as “guardrail”, is a semi-rigid barrier system consisting of connected lengths of corrugated steel rail held in place by steel or wood posts and blockouts. It is used to shield objects located near the roadway. The posts are installed directly in the soil and the blockouts are attached to the top of the posts. The rail is mounted on the blockouts, which offset the rail from the face of the posts. This reduces the chance that an impacting vehicle’s wheels will become snagged on the posts. Each end of the rail is anchored to the ground or to a stiff object such as a bridge end post.



**Figure 1:** Steel beam guardrail.

The Iowa DOT uses the Midwest Guardrail System (MGS) at a mounting height of 31 inches. With the MGS, barrier rail laps most commonly occur between the posts rather than at the posts. Typically, systems meeting Manual for Assessing Safety Hardware (MASH) Test Level 3 are installed. AASHTO's Roadside Design Guide provides more information regarding impact conditions for various test levels.

Two types of steel beam guardrail are available: W-beam and Thrie-beam, see below. W-beam has two corrugations. Thrie-beam has three, making it the stiffer of the two types.

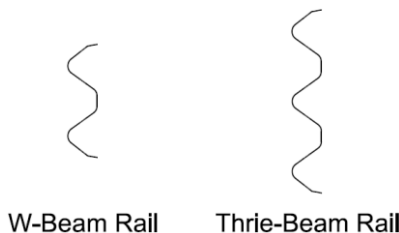

W-beam is more common and is used almost exclusively when steel beam guardrail is required. Thrie-beam has sometimes been used as a standalone barrier in locations where a smaller deflection distance is desired, such as at railroad signal footings (see [BA-204](#)). Thrie-beam is also used when transitioning from W-beam to a stiffer barrier type or to a fixed object (see [BA-201](#)).

## Parts of a Steel Beam Guardrail Installation

Every guardrail installation has at least three distinct parts: an anchorage at the approach (upstream) end, an anchorage at the trailing (downstream) end, and a standard run of guardrail between them. If the trailing end of a guardrail will be attached to a stiffer barrier or rigid object, the installation must also include a transition. Each of these parts is described in detail below.

### Anchorage

Anchorage provides tensile strength to a guardrail installation by attaching the end of the rail either to a rigid object or to the ground. Three types of anchorages are commonly used: bolted end anchors, beam end anchors, and end terminals. Depending on the design of an anchorage, it may or may not be considered crashworthy.

#### Bolted End Anchors

Bolted end anchors, such as those shown on Standard Road Plan and [BA-202](#), along with the barrier transition section (BTS) shown on [BA-201](#) are used to connect guardrail to a concrete barrier or a bridge rail end section. All of the [BA-202](#) anchors are considered crashworthy whether they are installed on the approach end or the trailing end of a guardrail installation.

#### Beam End Anchors

If the end of a guardrail will not be connected to a concrete barrier or bridge rail end section, it must be anchored to the ground. One way this is accomplished is through the use of a beam end anchor, such as the ones shown on [BA-203](#) (W-beam) and [BA-204](#) (Thrie-beam).

**Note:** These anchors are considered crashworthy only when installed on the trailing end of a guardrail installation. They should never be installed within the clear zone of approach traffic or in a location where end-on impacts into the anchor would be likely.

#### End Terminals

End terminals are also used to anchor the end of a guardrail to the ground, but they are considered crashworthy when impacted end-on. The [BA-205](#), [BA-206](#), and [BA-225](#) end terminals are considered crashworthy whether they are installed on the approach end or the trailing end of a guardrail installation. [LS-626](#) is the same as the BA-206. [LS-635](#) is the same as the BA-225.

The [LS-625](#) is for use on local systems roadways only. Do not use on Interstate or Primary highways.

An end terminal is designed to contain an impacting vehicle over only a portion of its length. For impacts occurring near the end of an end terminal, the rail is designed to bend or break away



(sometimes referred to as “gating”), allowing the vehicle to pass through. The point at which an end terminal becomes strong enough to contain a vehicle is called its length of need point. The length of need point is located at the traffic side face of rail at the center of post 3 (refer to Figure 2). Therefore, when laying out a guardrail installation, ensure that the vehicle departure path crosses the face of guardrail downstream of post 3 (see Figure 2).

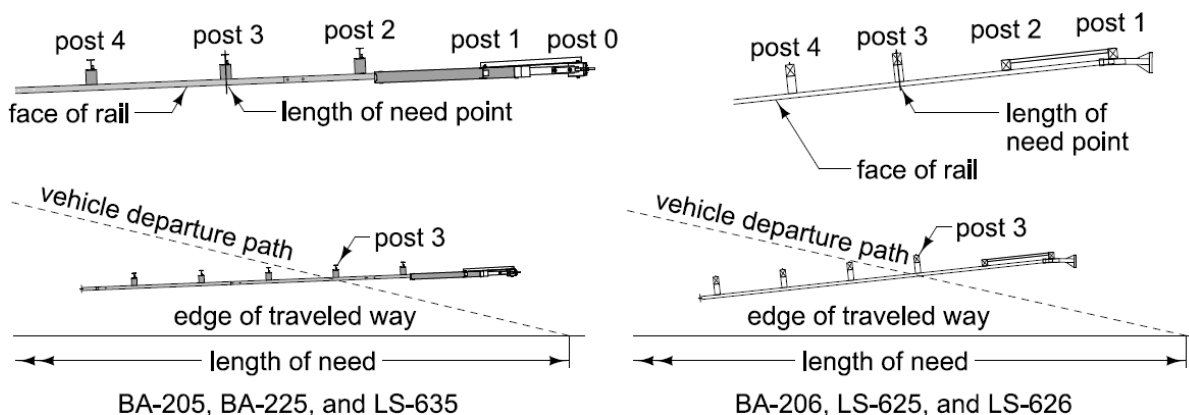

**Figure 2:** Placing length of need point for end terminals.

**Note:** Deflection within end terminals is greater than throughout the rest of the installation. Locate end terminals so the entire terminal is located upstream of the object being protected.

### Standard Run

The standard run of guardrail is that portion of an installation that lies between the anchorages. Typically, the standard run consists of 12'-6" sections of rail with posts spaced at 6'-3" intervals. However, post lengths and/or spacing within the standard run may vary depending on site characteristics, as discussed later.

**Note:** [BA-200](#) contains details of the posts, rail, and hardware used in the standard run and it is referenced by several other guardrail standards. Make sure to list [BA-200](#) in all plans that include guardrail.

### Transition

A transition must be used when guardrail will be attached to a more rigid object such as a bridge rail or concrete barrier. Details of the Barrier Transition Section (BTS) are shown on [BA-201](#). The design of this transition provides a gradual stiffening of the guardrail that more closely matches the strength of the rigid object at the point of attachment. The [BA-201](#) transition is considered crashworthy from either direction.

## Placement Requirements

The strength and proper functioning of guardrail depends highly on its relation to other objects in the vicinity. Therefore, placing guardrail in a manner consistent with the following paragraphs is very important.

### Placement near Fixed Objects

Steel beam guardrail is classified as a semi-rigid barrier. This means it is relatively strong, but it still deflects (moves backwards) when impacted by a vehicle. In order to provide a clear area for the guardrail (and the vehicle) to deflect into during an impact, guardrail must be installed a minimum of 5 feet (measured from the traffic side face of the guardrail to the face of the object) in front of any fixed object that is being shielded (see Figure 3). This distance can be reduced to 4 feet by installing the posts at half the standard post spacing (3'-1½"). Where half post spacing is used, it should begin a minimum of 12'-6" upstream of the fixed object and should continue a minimum of 12'-6" downstream of the object.

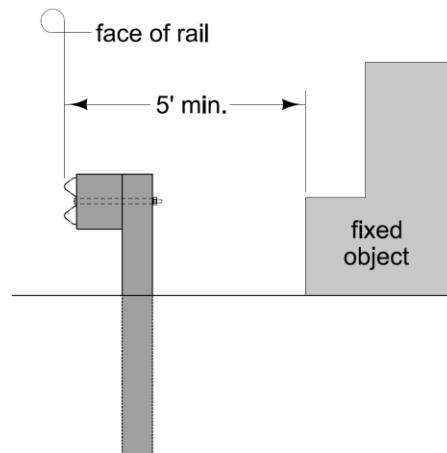

**Figure 3:** Guardrail in front of a fixed object.

Depending on site conditions, further reductions in deflection distance may be possible, see [Unique Situations](#) at the end of this section. Contact the [Roadside Safety Engineer](#) for assistance. Where very little deflection distance is available, consider shielding the fixed object with a concrete barrier.

Objects that are considered crashworthy or breakaway may be located within 5 feet of the face of rail only if relocating such objects to a point beyond the deflection area of the guardrail cannot be accomplished (see Figure 4). Care should also be taken to ensure that these objects, as well as any fixed objects, do not lie between the guardrail and the traffic. Such placement would greatly increase the chances of the objects being struck.

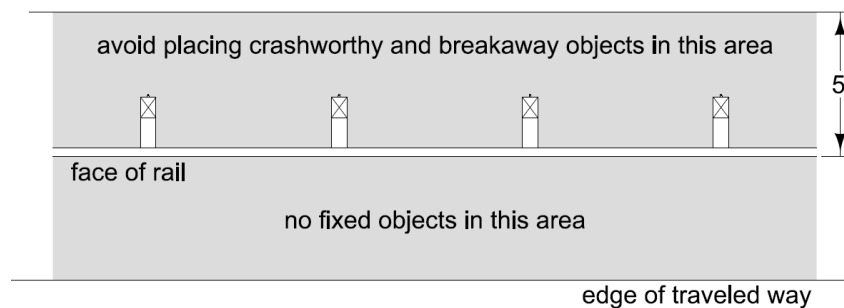

**Figure 4:** Placement of crashworthy or breakaway objects behind guardrail.

Placement of a guardrail's end terminal near fixed objects (including breakaway sign posts and light poles) should be avoided to the maximum extent possible. Designers should especially keep in mind the gating action of end terminals upstream of the length of need point (see Figure 2 on page 2), which allows vehicles to pass through the end terminal. Extending the guardrail to move the end terminal upstream of the fixed object (see Figure 5) is a good solution. Often, a clear area for the end terminal can be found a short distance upstream of the initial location.

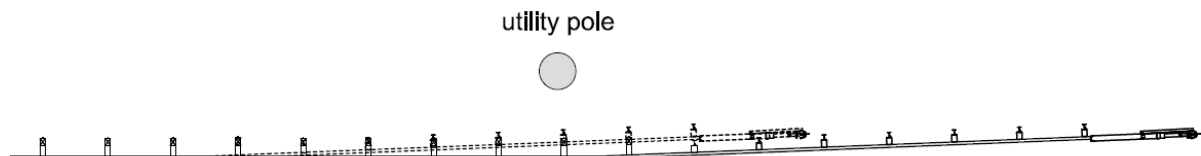

**Figure 5:** Extending guardrail to move end terminal upstream of fixed object.

### Placement near Slopes

Guardrail is typically placed on flat ground where slopes in front of and underneath the barrier are 10:1 or flatter. Placement on slopes steeper than 10:1 is not advised. This may result in some vehicles launching over the top of the rail or diving underneath the rail. Additionally, proper guardrail functioning depends largely on the strength of the soil behind the posts to provide the appropriate

amount of resistance to post rotation during an impact. Therefore, locating guardrail a sufficient distance in front of slopes is important in order to provide the desired level of soil resistance.

Use the following guidance when locating guardrail in front of slopes that are steeper than 10:1.

- In fill situations, the proper offset to use in front of a foreslope depends on the steepness of the slope. As shown in Figure 6, guardrail can be installed a minimum of 4 feet (5 feet is preferred) in front of any foreslope 2:1 or flatter. Where foreslopes are 6:1 or flatter, this distance can be reduced to 3 feet if necessary. If these conditions cannot be met, a special design may be needed, see [Unique Situations](#) at the end of this section. Contact the [Roadside Safety Engineer](#) for assistance.

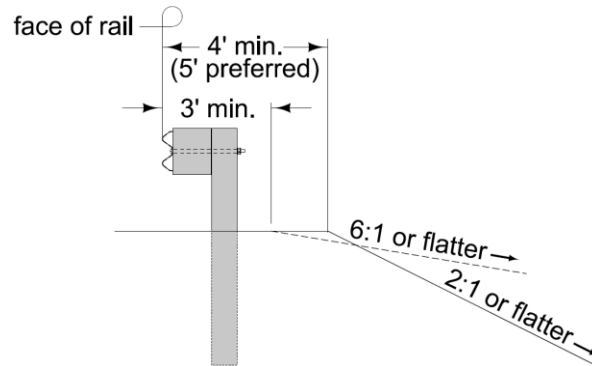

**Figure 6:** Guardrail in front of foreslopes.

- In cut situations, locate the guardrail a minimum of 3 feet from face of rail to the toe of the backslope as shown in Figure 7. Where backslopes are steeper than 1:1, locate the guardrail a minimum 5 feet from face of rail to toe of backslope.

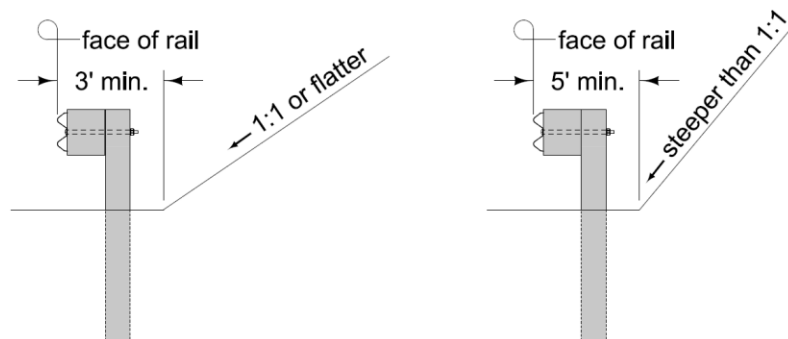

**Figure 7:** Guardrail in front of backslopes.

Placement of a guardrail's end terminal near steep backslopes should be avoided. Often, extending the guardrail farther upstream can provide a flatter area to locate the end terminal. When placement of the end terminal away from steep backslopes is otherwise unavoidable, provide a flat area around the end terminal of at least 5 feet to the toe of the backslope, see Figure 8.

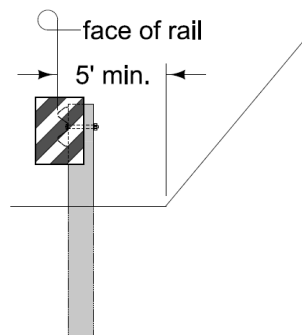

**Figure 8:** Placing an end treatment near a steep slope.

## Placement near Curbs

In general, the use of guardrail with curbs is discouraged. However, situations exist where it cannot be avoided. As discussed in Section [3C-2](#), curbs may be necessary to control drainage or to restrict access. Details of standard curb shapes and transitions are shown on [PV-102](#).

### Placement in Front of Curbs

While uncommon, guardrail may be installed in front of curbs, but no closer than 3 feet from the gutter line. Refer to Figure 9. This placement may not be desirable, however, because the posts will be located within the pavement, and the pavement will need to be blocked out or cut out around the posts (see [BA-200](#) for details).

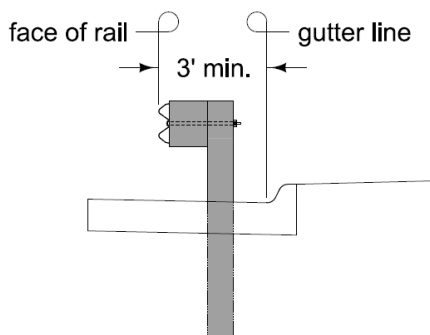
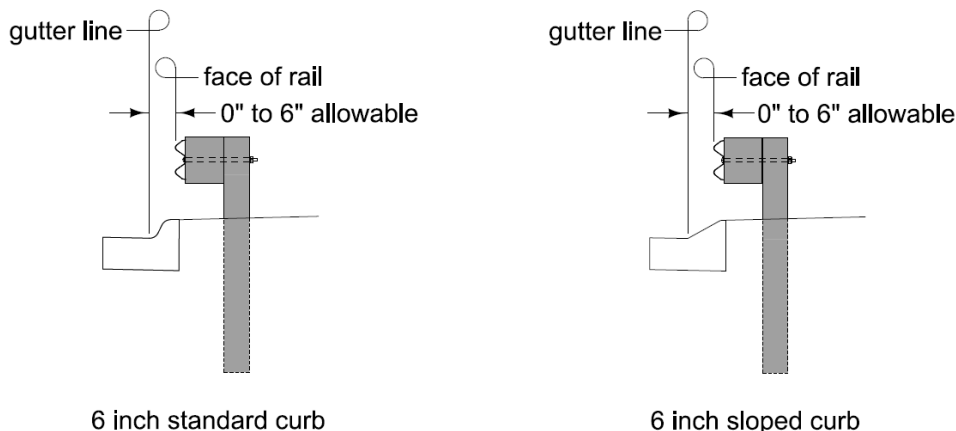

**Figure 9:** Guardrail in front of curbs.

### Placement behind Curbs

For guardrail installed behind curbs, follow the guidance below and as shown in Figure 10.

- Where 6 inch standard or 6 inch sloped curb is present, the face of guardrail must be located flush with, or within 6 inches of, the gutter line.

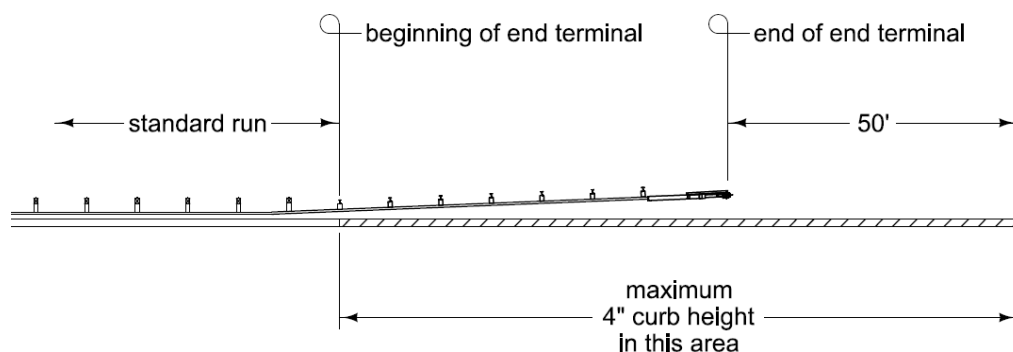

**Figure 10:** Guardrail behind curbs.

- Where 4 inch or shorter sloped curb is present, the face of guardrail should be located flush with the gutter line. Where this is not possible, it can be located any distance behind the curb.
- Where non-standard curb (such as tall or vertical faced curb) is present, contact the [Roadside Safety Engineer](#) for assistance.

If a curb is present, designing the guardrail so that its entire length remains in line with the curb (i.e. not using any flare) is preferable. However, all end terminals flare more than 6 inches over their length, so the only type of curb allowed in the vicinity of an end terminal is a 4 inch or shorter sloped curb. Where curbs higher than 4 inches exist or are proposed, they must be transitioned to a 4 inch or shorter sloped curb shape (see [PV-102](#) for transition details). This shape must extend the entire length of the end terminal and for a minimum of 50 feet in advance of the end terminal. Refer to Figure 11.





**Figure 11:** Maximum curb height near end terminals.

### Placement in the Median

A standard guardrail installation is considered crashworthy only for impacts that occur on the front side of the posts (the side with the rail). However, guardrail installations within the median may be subject to impacts from the back side as well.

Thus, for guardrail placed in the median, ensure the entire length of the installation is located outside the clear zone for traffic on the opposite side of the median. In narrow medians where this is not possible, a special design may be needed. Contact the [Roadside Safety Engineer](#) for assistance.

### Grading and Paving Requirements

Guardrail can be installed in well compacted granular material or soil. Guardrail can also be installed in pavement if a portion of the pavement around the posts is removed so that the posts are allowed to rotate freely. Refer to Standard Road Plan [BA-200](#) for specifics.

In general, the running (longitudinal) slope of a guardrail installation will follow the profile of the roadway. However, the cross slope along a roadway may vary. As mentioned previously, guardrail should only be installed on cross slopes that are 10:1 or flatter.

Existing slopes rarely provide a cross section that is desirable for placement of new or updated guardrail. Therefore, most projects will require some degree of grading and/or paving to meet the requirements described below.

#### Grading for Guardrail

Grading requirements for typical guardrail installations are shown on Standard Road Plan [EW-301](#). While this standard covers the required grading needed throughout an entire guardrail installation, the most critical grading area is adjacent to, and in advance of, the end terminal. Therefore, foreslopes in this area should be kept as flat as possible. And as discussed previously, no fixed objects should be located within this critical area.

Proper functioning of the end terminal depends highly on the stability of the vehicle that impacts it. Bumping out the grading to provide a wide, flat area (also called the “blister”) around the end terminal increases the chance that an impacting vehicle will be in a stable condition once it reaches the end terminal. The slope of the blister should match the adjacent shoulder out to the guardrail posts, and break to 10:1 behind the posts.

On [EW-301](#), the slope behind the guardrail and at the blister is labeled “Foreslope at Guardrail.” This is a design value that must be entered into Tabulation [107-23](#) along with other grading variables.

- **Installations on the roadside.** The preferred value for “Foreslope at Guardrail” is 4:1 or flatter. Where right-of-way or other restrictions exist, this slope can be steepened to 3:1. Where this cannot be accommodated, if the normal foreslope in the area adjacent to the guardrail installation is steeper than 3:1, it may be acceptable to provide a “Foreslope at Guardrail” that matches the normal foreslope. However, this decision must be documented.

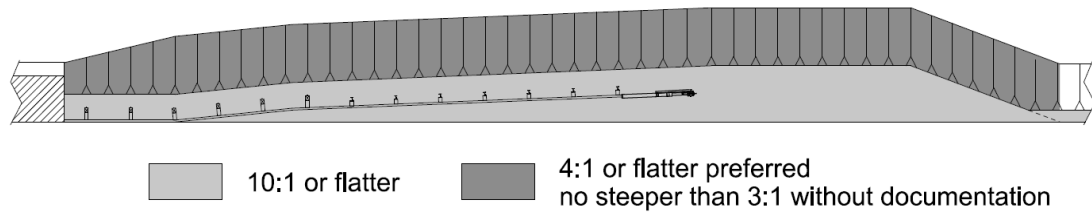

**INTERSTATE PROJECTS ONLY:** “Foreslope at Guardrail” cannot be steeper than 4:1 in the area immediately behind, and in advance of, the end terminal. It may be steeper than 4:1 for all other areas behind the guardrail.

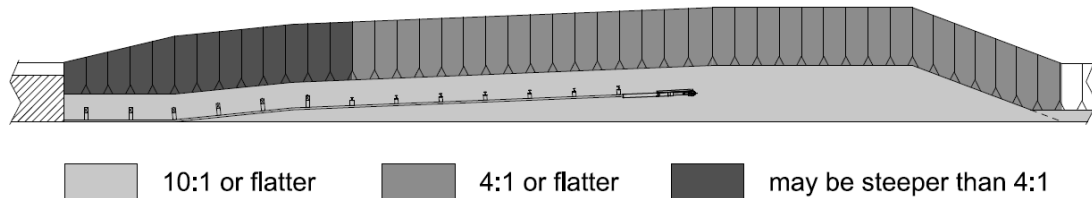

- **Installations within the median.** The preferred value for “Foreslope at Guardrail” is 6:1 or flatter. Where this cannot be accommodated, the slope should be no steeper than 4:1 within the clear zone.

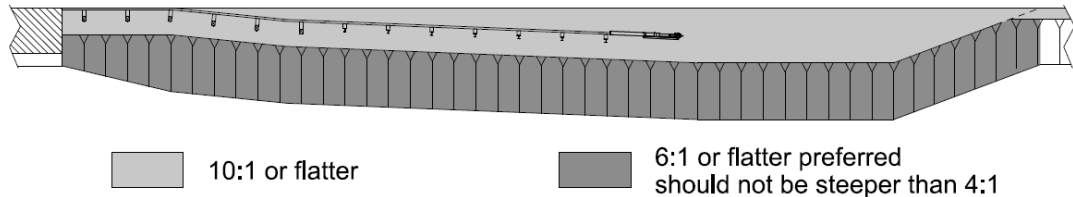

**INTERSTATE PROJECTS ONLY:** “Foreslope at Guardrail” cannot be steeper than 4:1 within the clear zone.

### Paving in Front of Guardrail

Typicals [7156](#), [7157](#), and [7158](#) show the method of providing a paved surface in front of a guardrail installation. This design eases maintenance and ensures a smooth approach surface for vehicles that may impact the guardrail. Use of these typicals is required on new construction and reconstruction projects, and is highly encouraged on all other projects. Where a question exists about whether to incorporate Typical 7156, 7157, or 7158 into a project, consult the District Office.

When using Typical [7156](#), [7157](#), and [7158](#), a short transition is needed between variable tangent (VT) or variable flare (VF) and BA-205 because VT and VF use 12 inch blockouts and BA-205 uses 8 inch blockouts. BA-225 also uses 8 inch blockouts and requires the same transition. The transition is a 12.5 foot section of W-beam with a slight bend, see Figure 12 below.

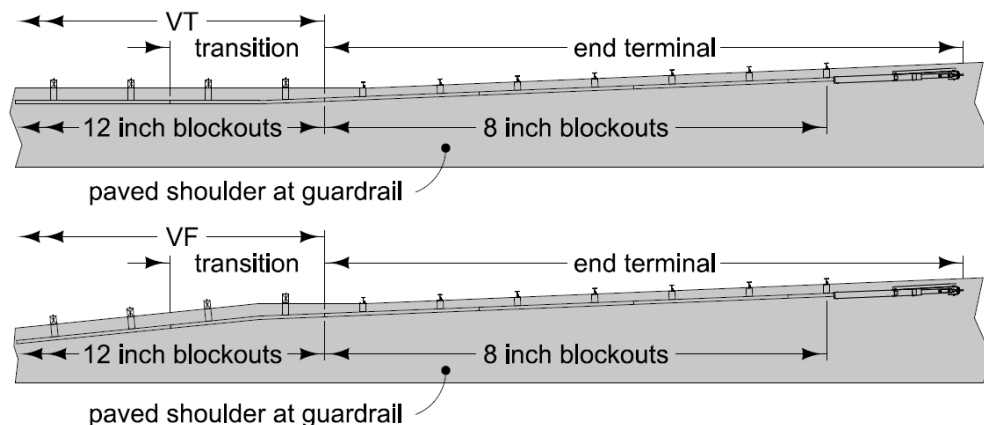

**Figure 12:** Transition from VT or VF to BA-205 and BA-225.



This bend allows a smooth transition of the pavement edge from 12 inch blockouts to 8 inch blockouts. The guardrail cell library has two cells for this transition: **MGS\_VT\_to BA-205\_or\_BA-225** and **MGS\_VF\_to BA-205\_or\_BA-225**. As shown in Figure 12, these are placed immediately downstream of the end terminal.

Note: Typical [7156](#), [7157](#), and [7158](#) are not intended for use with curbs or on unpaved roads.

## Laying Out a Guardrail Installation

### Length

A guardrail installation must be long enough to adequately shield the chosen object. Determining whether an installation is long enough requires proper establishment of the vehicle departure path. For guidance on determining the vehicle departure path, refer to Section [8B-6](#).

- Approach end: A guardrail installation is considered long enough to adequately shield the approach end of an object when the vehicle departure path crosses the face of guardrail at or downstream of the end terminal's length of need point (refer back to [Figure 2](#) on page 3).
- Trailing end:
  - For one way independent guardrail installations, such as those illustrated on [BA-252](#), the installation is considered long enough to adequately shield the trailing end of an object when the guardrail terminates at least 37.5 feet beyond the end of the object.
  - For two way independent guardrail installations, such as those illustrated on [BA-251](#), the trailing end is treated as another approach end, but from the opposite direction.

Guardrail segments can be installed either in a tangent or flared configuration. Tangent segments parallel the roadway centerline, whereas flare segments diverge away from the centerline at a 10:1 rate. The length of these segments is defined through the use of variable tangent (VT) and variable flare (VF) sections. The term "variable" indicates that these dimensions are chosen by the designer, using 12.5 foot increments.

The best combination of VT and VF to use depends on the site characteristics. As figure 11 in Section [8B-6](#) demonstrates, using VF may reduce the overall amount of guardrail needed. However, the amount of earthwork required may increase because the installation terminates a greater distance from the edge of roadway. A design such as this works well in areas with flat foreslopes, where only a minimal amount of earthwork would be needed to accommodate the VF. Decreasing VF reduces earthwork because the installation remains closer to the edge of roadway. However, it increases the overall amount of guardrail needed. A design such as this works well in areas with steep foreslopes, where earthwork needed to accommodate VF can be excessive. Figure 13 demonstrates these relationships.

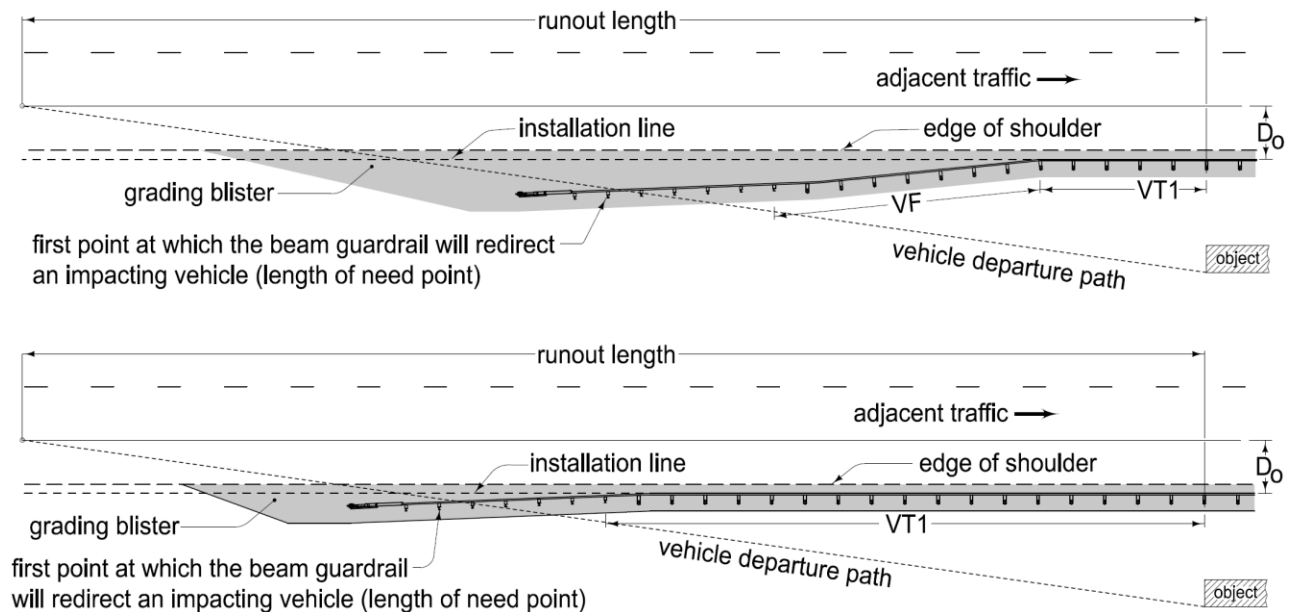

**Figure 13:** Effects of VT and VF on grading blister and earthwork.

### Offset

Offset is a term that describes how far from the road (or from the shoulder) a tangent segment of guardrail is located. The offset at VT1 (the segment located closest to the road) is of particular importance because it serves as a baseline for the entire installation.

Where guardrail is connected to a bridge, offset is already determined by the bridge end section. For independent guardrail installations, the offset at VT1 is defined as  $D_0$  and is measured from the edge of traveled way to the traffic side face of the guardrail.

Designers choose  $D_0$  based on the placement guidance provided earlier, and tabulate it in the plans. Designers need to keep in mind that the choice of  $D_0$  will have an impact on earthwork, especially in high fill areas. More offset will require a larger blister, which means more earthwork; however, it will reduce the likelihood of incidental hits. Less offset will require a smaller blister and less earthwork, but will increase the likelihood of incidental hits. Designers also need to consider traffic volumes. The higher the traffic volume, the higher the risk of incidental hits. Thus, choosing an appropriate  $D_0$  requires designers to balance the effects of earthwork required and traffic volumes.

### Offset to Guardrail

The proper offset to use varies depending on the type of guardrail installation:

- **Long, continuous installations:** The guardrail should be located a minimum of 2 feet off the edge of shoulder to reduce the possibility of nuisance hits. Where this is not possible or practical, it can be even with the edge of shoulder.

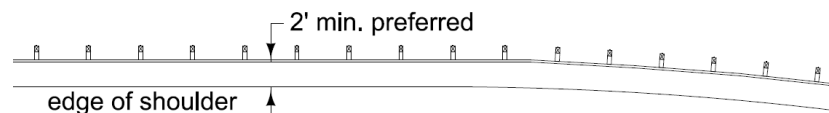

- **Installations at Full Shoulder Width Bridges:**

- On Interstates, flare should be used to locate the VT2 segment 2 feet behind the edge of shoulder (minimum of 12 feet from the edge of traveled way for the nearest traffic lane). On the median side, locating the VT2 segment 12 feet from the edge of traveled way is preferred unless this would locate the end terminal within the clear zone for opposing traffic. In these cases, reduce the amount of flare, or eliminate the flare altogether.

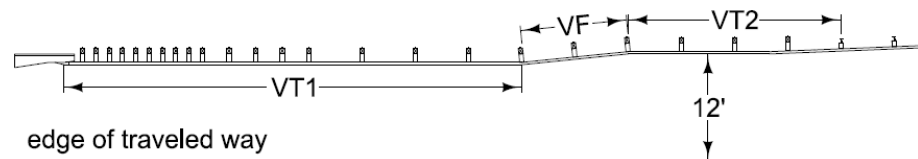

- On all other routes, the use of flare is not necessary. The guardrail should be kept behind the edge of the shoulder.

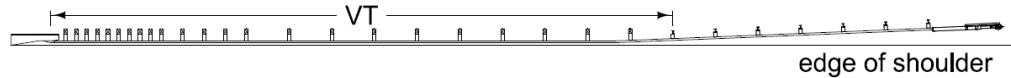

• **Installations at Less than Full Shoulder Width Bridges:**

- On Interstates, follow the same guidance as for full shoulder width bridges.
- On all other routes, flare should be used to locate the VT2 segment behind the edge of the shoulder.

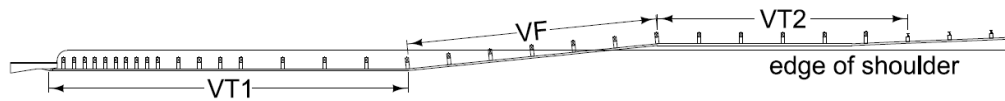

- **Installations at Spot Locations:** The offset value for VT1 should be a minimum of 2 feet from the edge of traveled way. This is referred to as “shy distance”. VT1 should be located as far from edge of traveled way as possible while still allowing for deflection of the guardrail (see Placement Requirements above).

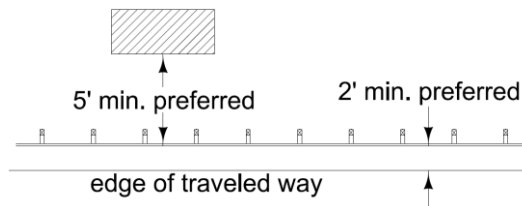

For shorter guardrail runs, the offset is less critical. However, the length of any guardrail placed within the normal shoulder width should be minimized.

**Offset to End Terminals**

On the approach end, the traffic side face of the end terminal must be located even with, or beyond, the edge of the shoulder. Where practical, include variable flare sections to ensure the end of the [BA-205](#) terminal is located at least 2 feet off the shoulder. This helps reduce incidental hits.

On the trailing end, the same guidance generally applies. However, where the minimum length of guardrail provides the necessary length of need, do not extend the guardrail for the sole purpose of locating the end terminal off the shoulder. The face of the end terminal on the trailing end may be located within the normal shoulder.

**Barrier at Bridge Rail End Sections ([BA-250](#))**

The minimum VT1 is 53.125 feet. Where longer VT1 lengths are desired, increase this number by 12.5 foot increments. Possible VT1 lengths include: 53.125 feet, 65.625 feet, 78.125 feet, etc.

Although VF and VT2 may come in 6.25 foot increments, the sum of these two must be divisible by 12.5 feet. While not required, it is recommended that any VF or VT2 lengths used be divisible by 12.5 feet – especially since the VF and VT MicroStation cells are each 12.5 feet long.

**Recovery Area**

Vehicles can continue to travel behind a guardrail installation after impacting the terminal head, especially if the end terminal is non-energy absorbing ([BA-206](#)). A clear recovery area – a traversable area free of objects – should be provided as shown in Figure 14 whenever possible.

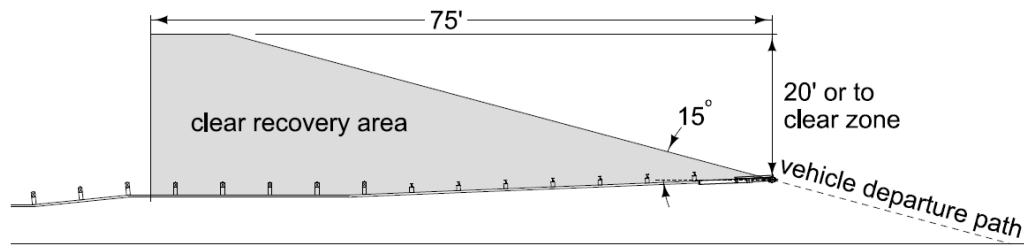

**Figure 14:** Recovery area behind guardrail installation.

### Use of Guardrail Cells

Special cells have been developed for use in laying out guardrail installations. The cells are located in the `dsnGuardrail.cel` file which can be accessed either through Geopak's Design & Computation Manager or through the MicroStation cell libraries.

Use of the cells is required on state projects and is highly encouraged on other projects. This leads to consistency in guardrail design and it aids in filling out the guardrail tabulations. Use of the cells also makes it easy to visualize when a proposed installation is long enough to shield a particular object, and to see how different combinations of VT and VF affect the overall length of an installation.

Each cell represents a small piece of a guardrail installation, such as a [BA-201](#) barrier transition section, or a [BA-205](#) end terminal. Variable tangent and variable flare pieces are also available, and come in standard 12.5 foot rail segments. Individual rail pieces are linked together to form a larger installation. Other than mirroring and/or rotating, the cells should not need to be modified.

Once the vehicle departure path has been established and drawn in MicroStation, the guardrail installation can be laid out using the cells. It may be easiest to start from the downstream end – especially if that end point is well established, such as an attachment to a bridge. Continue adding VT and/or VF sections until about 50 feet of space is left between the last guardrail cell and the departure path. Then place the end terminal cell and check whether the departure line crosses after the length of need point (refer back to [Figure 2](#) on page 3). If it doesn't, add more VT or VF sections and try again.

Placing cells on straight segments of roadway is relatively simple. However, placing cells on a curved segment is more involved. Because the guardrail installation line follows the curvature of the road, each cell will need to be rotated slightly to maintain a constant offset. Establishing a guide installation line for the guardrail cells to follow is helpful. This can be done by making a parallel copy of the roadway centerline (or the edge of pavement) at the desired offset.

The hardest part of a curved layout involves proper placement of the end terminal. This requires a slight modification to the flare of the end terminal cell. When modifying the cell, do not add curvature to the rail; instead, adjust only the angle of the bend and keep the rail straight over its entire length (see [Figure 15](#)).

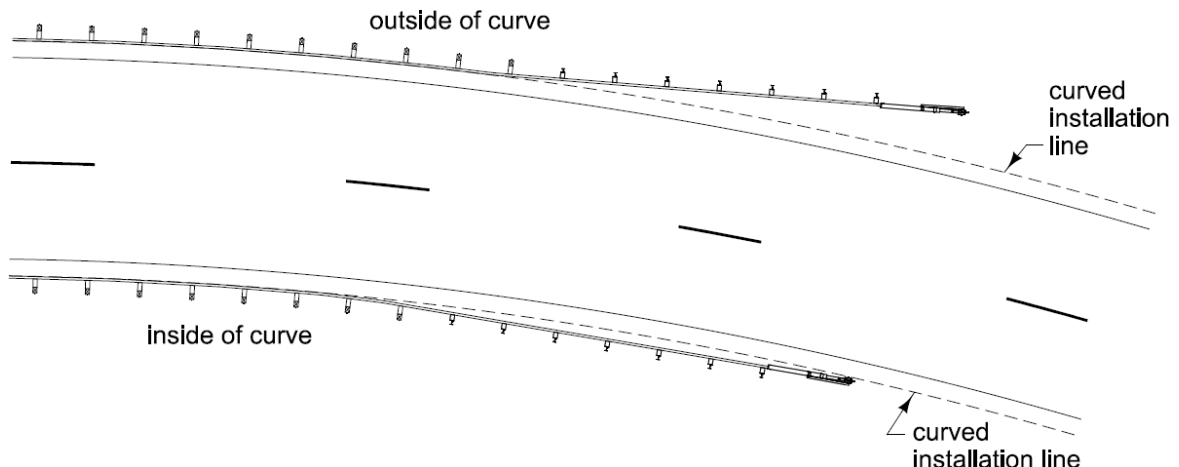

**Figure 15:** Placement of the end terminal in a curve.

## Pay Length

The pay length for the Steel Beam Guardrail item is the length between the End Terminal and the Barrier Transition Section (or the End Anchor and the End Terminal). This length will be divisible by 12.5 feet. Refer to the guardrail layouts in the BA-250 and BA-260 series.

## Use of Standard Road Plans

### Component Standards vs. Layout Standards

Standard Road Plans covering steel beam guardrail are located in the [BA-200 series](#). The lower numbered BA-200s contain the component type standards. These standards show the details of specific pieces of a guardrail installation, such as a transition or an end terminal. The BA-250s and BA-260s contain the layout type standards. These standards show how an overall guardrail installation is pieced together using the component standards.

Each layout standard contains two sets of dimensions: layout lengths and pay lengths. Layout lengths are dimensions used by contractors to assemble an installation in the field. These are tabulated dimensions (VT1, VF, etc.) that identify the length of straight sections of rail, and they are measured between posts. Pay lengths define the limits of individual contract items within an overall guardrail installation, and they are measured between rail splices.

**Note:** The sum of the layout lengths will always equal the sum of the pay lengths.

### Design Considerations for Specific Standards

The most commonly used guardrail standards are discussed in further detail below. These standards are not intended to address every situation. Where site conditions do not allow for use of the standards, a special design may be needed. Contact the [Roadside Safety Engineer](#) for assistance.



[BA-221](#), [BA-225](#), and [BA-260](#) are for use on low speed (45 mph or less) or low volume (400 vehicles per day or less) roadways. Contact the [Roadside Safety Engineer](#) prior to use.

**[BA-200](#): Components.** This standard provides specifics on the posts, rail, and hardware common to all guardrail installations, and it also shows some typical construction details.



List BA-200 in the tabulation of standard road plans for every project that includes guardrail.

**[BA-201](#): MASH TL-3 Barrier Transition Section (BTS).** This standard shows the approved method for transitioning a guardrail installation to a more rigid barrier such as a bridge rail or concrete barrier.

**[BA-202](#): Bolted End Anchor.** This standard shows the method of attaching guardrail to a concrete barrier or bridge endpost. This connection varies slightly depending on the style of bridge endpost. Use a Type A connection with non-flared bridge endposts or concrete barrier end sections (see [BA-107](#)). Use a Type B connection with non-flared retrofit bridge endposts. Use a Type C connection with flared bridge endposts. For other styles of endposts, a special design is required. Contact the [Roadside Safety Engineer](#) for assistance with special designs.

**[BA-203](#): W-Beam End Anchor.** This standard contains details for anchoring guardrail to the ground when a crashworthy terminal is not required. Do not use BA-203 to anchor a high tension cable to steel beam guardrail connection (see [Section 8C-3](#)) without first contacting the [Roadside Safety Engineer](#). A minimum of 37.5 feet of W-beam (includes End Section W-beam Rail) should extend beyond the downstream end of the object, see Designer Info for [BA 200s](#).

**[BA-205](#): MASH TL-3 End Terminal.** This standard provides information on the design of the standard end terminal. This is the preferred end terminal and it should be used whenever possible on Primary and Interstate roads.

The BA-205 uses 8 inch blockouts. Since variable tangent (VT) and variable flare (VF) both use 12 inch blockouts, a small section of W-beam with a slight bend is needed to make the transition from VT or VF to BA-205, see [Paving in Front of Guardrail](#).

Lesser offsets than that shown in BA-205 may be used, down to 0 feet. Where these lesser offsets are desired, make sure to call this out in the estimate reference notes.

**BA-206: Flared End Terminal.** This standard provides information on the design of the flared end terminal. This standard is intended to be used where high tension cable guardrail is connected to steel beam guardrail. It may be used in locations without cable where the need exists for an end terminal that is shorter or has a greater offset than the standard [BA-205](#) end terminal. Do not use for such an installation without first contacting the [Roadside Safety Engineer](#). The BA-206 is a gating terminal rather than an energy absorbing terminal like the BA-205. Vehicles that impact the end of the BA-206 may continue to travel behind the guardrail. Designers will need to ensure a [recovery area](#) exists for vehicles that pass through the end terminal.

As shown in the plan view, the rail at the end of the terminal is offset 4 feet from the installation line. This is the only allowable offset – lesser offsets cannot be used.

**BA-221: MASH TL-2 Barrier Transition Section (BTS).** This standard shows the approved MASH TL-2 method for transitioning a guardrail installation to a more rigid barrier such as a bridge rail or concrete barrier.

**BA-225: MASH TL-2 End Terminal.** This standard provides information on the design of the MASH TL-2 standard end terminal.

The BA-225 uses 8 inch blockouts. Since variable tangent (VT) and variable flare (VF) both use 12 inch blockouts, a small section of W-beam with a slight bend is needed to make the transition from VT or VF to BA-225, see [Paving in Front of Barrier](#).

Lesser offsets than that shown in BA-225 may be used, down to 0 feet. Where these lesser offsets are desired, make sure to call this out in the estimate reference notes.

**BA-250: MASH TL-3 Installation at Concrete Barrier or Bridge Rail End Section.** This standard shows how several of the component standards are pieced together to provide a guardrail installation that attaches to a concrete barrier or bridge rail end section.

The minimum length of VT1 is 53.125 feet. This consists of the 37.5 foot BTS plus an additional 15.625 feet of W-beam. When connecting directly to BA-205, the last 12.5 feet of the 15.625 foot section of W-beam is needed to transition from the 12 inch blockouts of the VT to the 8 inch blockouts of BA-205. When an installation requires VF upstream of the BTS, the last 12.5 feet of the 15.625 foot section of W-beam is required to move the VT to VF transition upstream of the BTS. Figure 16 demonstrates the minimum V1 length.

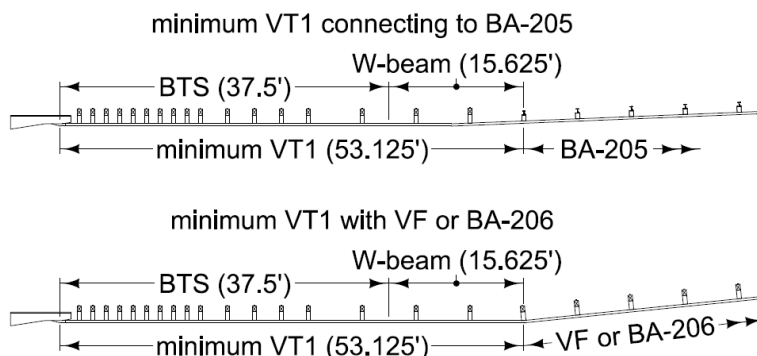

**Figure 16:** Sample minimum VT1 lengths for [BA-250](#).

The minimum layout lengths for BA-250 (no VF) are:

$$\text{BA-201 with BA-205} = 53'-1\frac{1}{2}" + 47'-8" = 100'-9\frac{1}{2}"$$

$$\text{BA-201 with BA-206} = 53'-1\frac{1}{2}" + 37'-6" = 90'-7\frac{1}{2}"$$



In order to limit the possibility of an impacting vehicle snagging on the concrete endpost, a 4 inch sloped curb should be provided underneath the guardrail in the area adjacent to the endpost. The curb should start at the endpost and extend parallel to and outward from the endpost a minimum of 12.5 feet, see Figure 17. This curb is required for projects on the NHS and is preferred on all other projects. As shown in Figure 17, the curb should end either before the asymmetrical transition or beyond the BTS. See [PV-102](#) for curb drop details. How far the curb is extended beyond the BTS is influenced by the presence of bridge end drains. Section [4C-2](#) provides more information regarding locating bridge end drains.

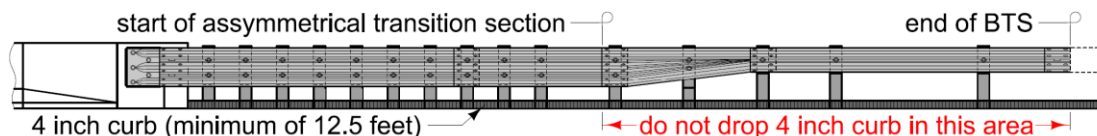

**Figure 17:** 4 inch sloped curb at BTS.

**BA-251: Installation at Side Object (Two-Way Protection).** This standard shows the method of shielding an object with a structurally independent guardrail installation. It is used where both ends of the guardrail may be subject to impacts (i.e. the trailing end is within the clear zone of opposing traffic).

**BA-252: Installation at Side Object (One-Way Protection).** This standard also shows the method of shielding an object with a structurally independent guardrail installation. It is used where only the approach end of the guardrail may be subject to impacts (i.e. the trailing end is beyond the clear zone of any opposing traffic).

**BA-260: MASH TL-2 Installation at Concrete Barrier or Bridge Rail End Section.** This standard shows how several of the component standards are pieced together to provide a MASH TL-2 guardrail installation that attaches to a concrete barrier or bridge rail end section.

The minimum length of VT1 is 37.5 feet. This consists of the 21.875 foot BTS plus an additional 15.625 feet of W-beam. When connecting directly to BA-225, the last 12.5 feet of the 15.625 foot section of W-beam is needed to transition from the 12 inch blockouts of the VT to the 8 inch blockouts of BA-225. When an installation requires VF upstream of the BTS, the last 12.5 feet of the 15.625 foot section of W-beam of is required to move the VT to VF transition upstream of the BTS. Figure 18 demonstrates minimum V1 lengths.

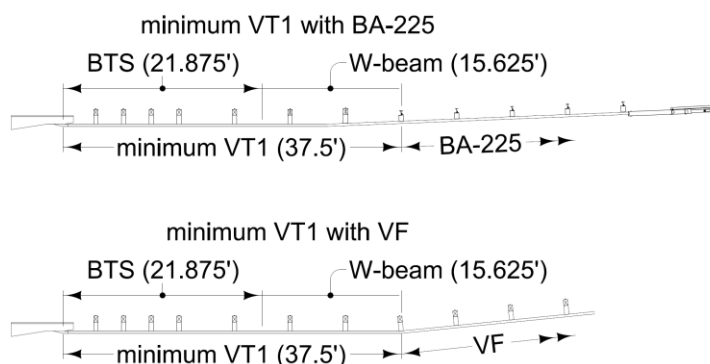
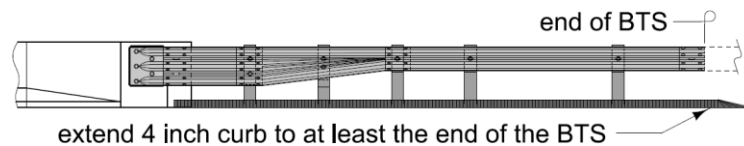

**Figure 18:** Sample minimum layout lengths for [BA-260](#).

The minimum layout length for BA-260 is:

$$\text{BA-221 with BA-225} = 21'-10\frac{1}{2}" + 3'-1\frac{1}{2}" + 12'-6" + 35'-2" = 71'-8"$$

In order to limit the possibility of an impacting vehicle snagging on the concrete endpost, a 4 inch sloped curb is recommended underneath the guardrail in the area adjacent to the endpost. When used, the curb should start at the endpost and extend parallel to and outward from the endpost to at least the end of the BTS before transitioning to a no curb section, see Figure 19.



**Figure 19:** 4 inch sloped curb at BTS.

## Unique Situations

Designers occasionally encounter unique situations that require special guardrail designs. Listed below are some examples along with potential solutions:

- **Problem:** face of guardrail is located closer than 4 feet to an object, requiring the need for more reduced deflection than can be achieved using the half post spacing suggested in the Placement near Fixed Objects discussion. **Possible solutions:** reduce post spacing to one quarter the standard post spacing (1'-6¾"), or nest the guardrail. Tables 5-4 and 5-6 of the 2011 Roadside Design Guide shows the reduction in deflection resulting from half and quarter post spacing. Table 5-6 demonstrates the reduction in deflection resulting from using half and quarter post spacing, as well as nested W-beam. If using quarter post spacing, it should begin a minimum of 12'-6" upstream of the fixed object and should continue a minimum of 12'-6" downstream of the object. Transition to the quarter post spacing using 12'-6" of half post spacing upstream and downstream of the quarter post spacing.

**Note:** The results shown in Table 5-6 of the Roadside Design Guide consist primarily of computer simulations and have yet to be verified with field tests.

- **Problem:** an intake is located where a post is to be located. **Possible solutions:** use multiple 8 inch spacer blocks in place of the 12 inch spacer block so post can be placed behind intake, skip a post, or use a surrogate post (contact the [Roadside Safety Engineer](#) for details).

**Note:** If using two 8 inch spacer blocks, this can be done for several consecutive posts. If using three 8 inch spacer blocks, this can only be done on one post.

**Note:** Skipping a post cannot be done within the BTS ([BA-201](#)) or the end treatment ([BA-205](#), [BA-206](#), or [BA-225](#)). A surrogate post may be used in the BTS, but not in the end treatment.

- **Problem:** guardrail needs to be placed closer to an adjacent foreslope than shown in the Placement near Slopes discussion. **Possible solutions:** decrease post spacing and/or substitute 9 foot posts for 6 foot posts. Discuss with the [Roadside Safety Engineer](#) prior to using these options.
- **Problem:** side road or entrance in a rural area is located such that it interferes with placement of MASH TL-3 guardrail installation at a side object. **Possible solutions in order of preference:**
  1. Move the side road or entrance if feasible.
  2. Use a crash cushion instead of steel beam guardrail if the object is narrow enough and no secondary objects need protection. Total installation length depends on the crash cushion (typically 35 to 50 feet). Refer to [MAPLE](#) for approved crash cushions. Designers may need to specify a particular type of crash cushion to fit the situation. This will require a Public Interest Finding (also referred to as a PIF, see Section [1C-7](#)) for roads that are part of the NHS.
  3. Use a MASH TL-2 guardrail installation if the object is too wide to protect with a crash cushion or secondary objects need protection. If the posted speed is greater than 45 mph, document the decision in the same manner as a variance, see Section [1C-8](#).
  4. Use [short radius curved guardrail](#). Document the decision in the same manner as a variance, see Section [1C-8](#).

Short radius curved guardrail has not passed either NCHRP 350 or MASH at TL-3, but has passed NCHRP 350 at TL-2; therefore, it should only be used as a last resort. Designers should first investigate other options.



- Problem: urban setting where a standard MASH TL-3 guardrail installation won't fit. Possible solution: may be able to use a MASH TL-2 system if posted speed is 45 mph or less.
- Problem: narrow median resulting in steel beam barrier rail for opposing traffic (perhaps for a bridge rail end section) being located within the clear zone. Possible solutions: use high tension cable barrier (see Section [8C-3](#)) instead, or contact the [Roadside Safety Engineer](#) for details for median treatments.

As noted, these are possible solutions for designers to examine. They may not be the best solutions. Designers should work with the [Roadside Safety Engineer](#) to determine the best solution for a given situation.