



TRAFFIC FLOW MAP OF

DAVENPORT B

SCOTT COUNTY

2010 ANNUAL AVERAGE DAILY TRAFFIC

\* REVISED 9 /2011

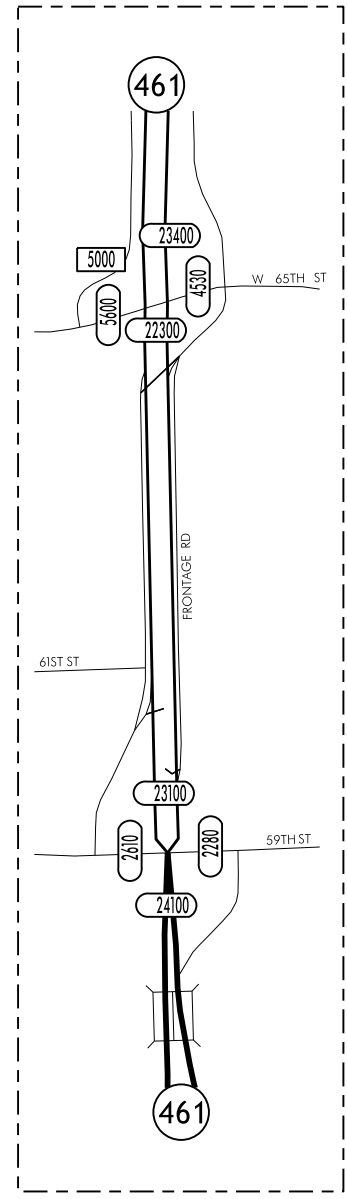
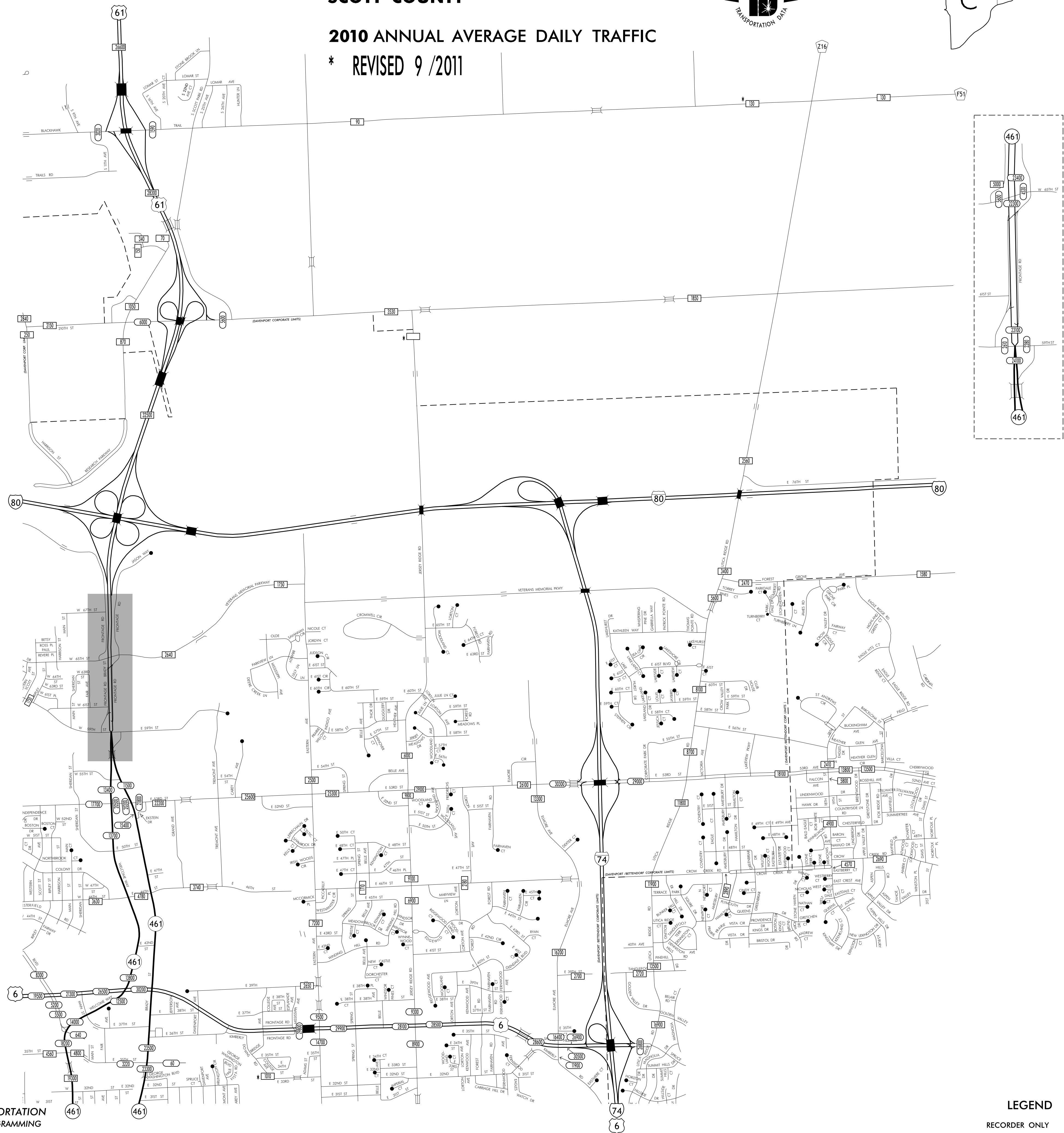
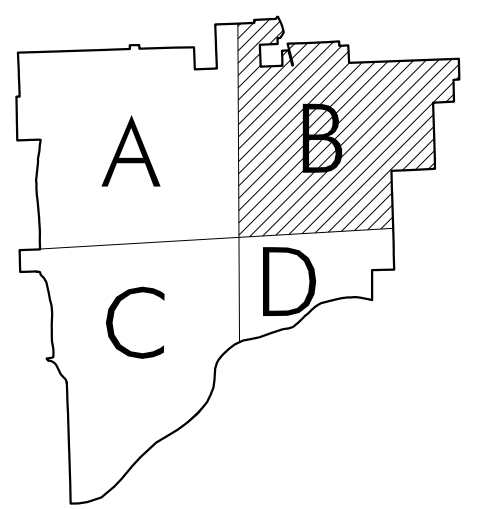

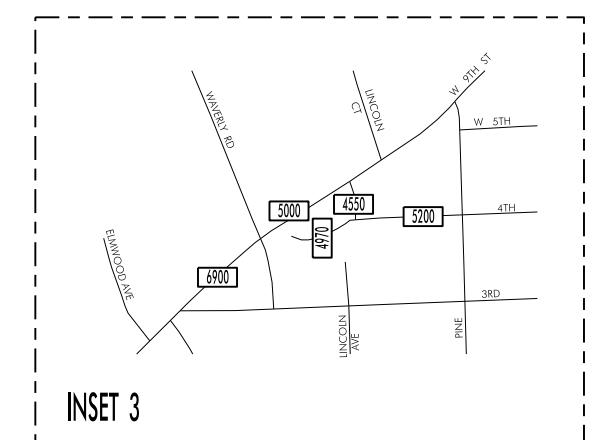
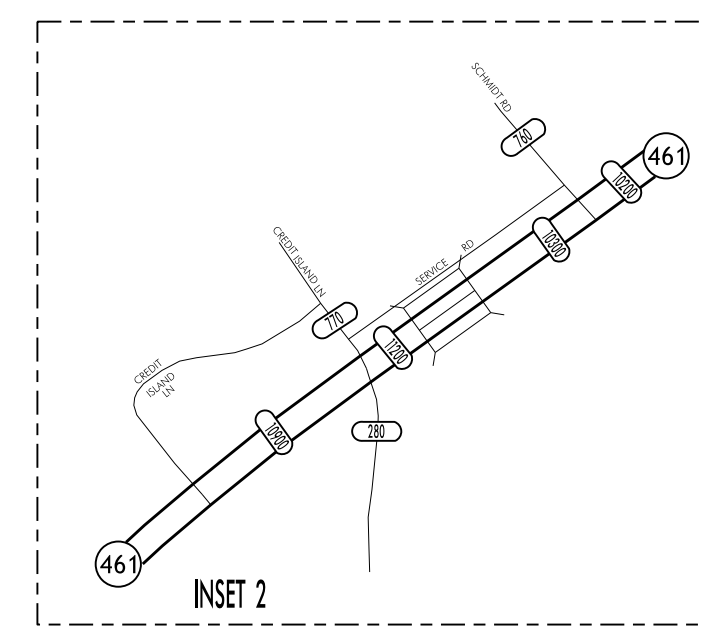
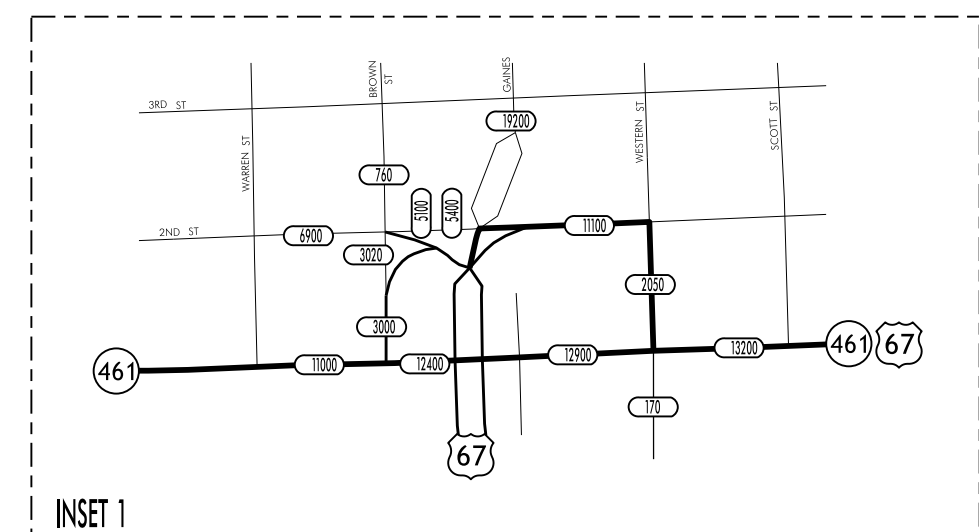
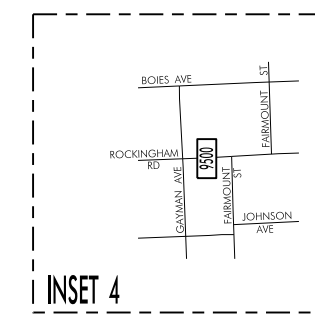
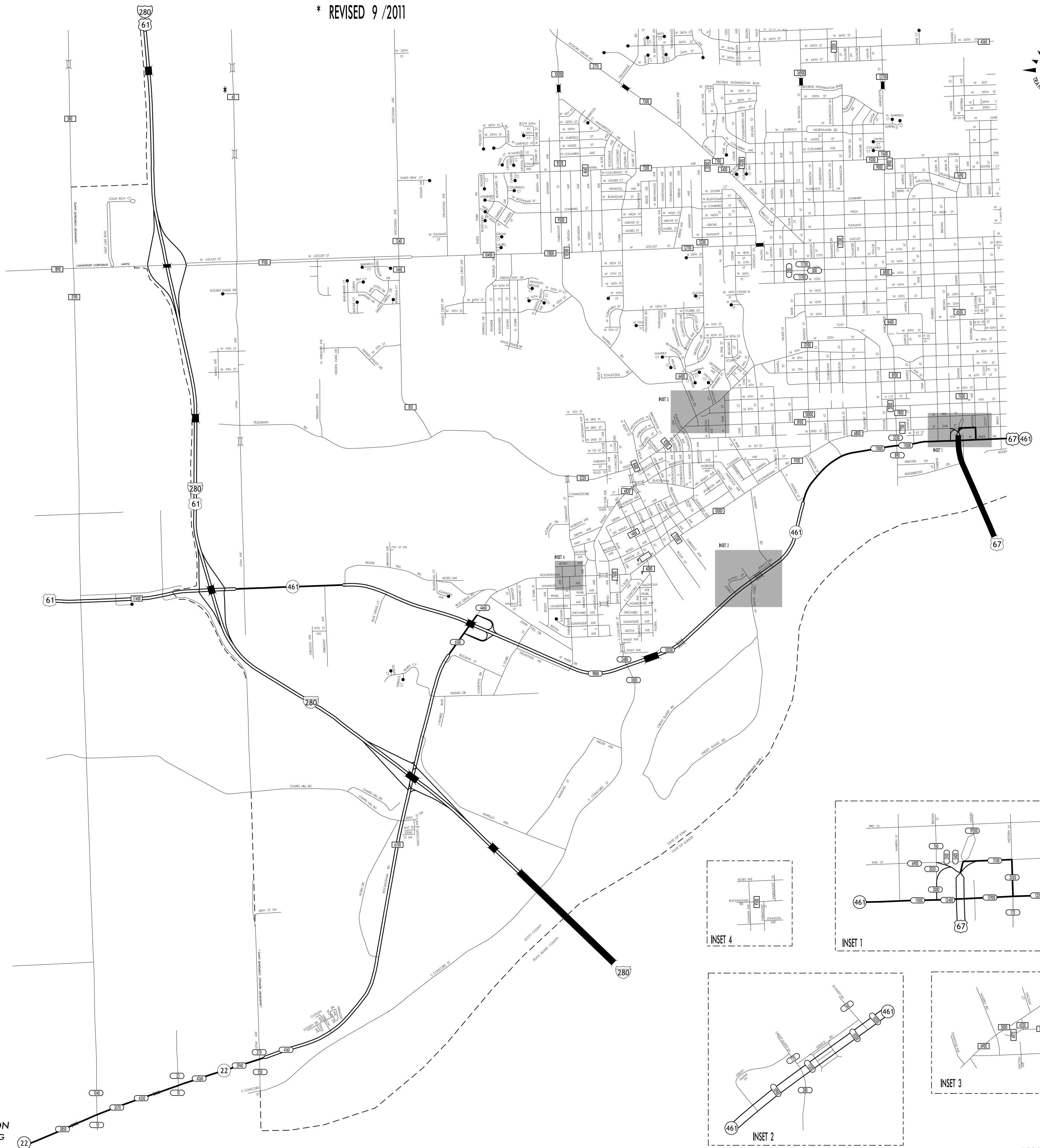
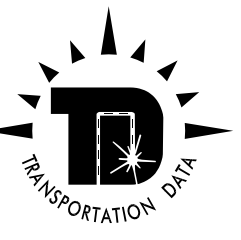
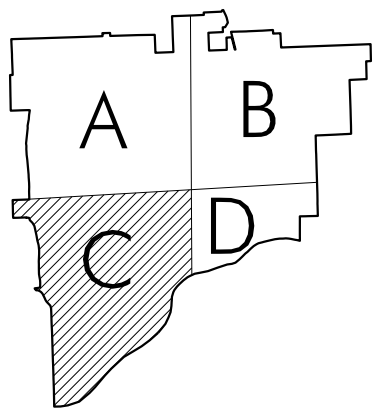

LEGEND

RECORDER ONLY  
MANUAL COUNT

