

TRAFFIC FLOW MAP OF
COUNCIL BLUFFS A
POTTAWATTAMIE COUNTY
2012 ANNUAL AVERAGE DAILY TRAFFIC

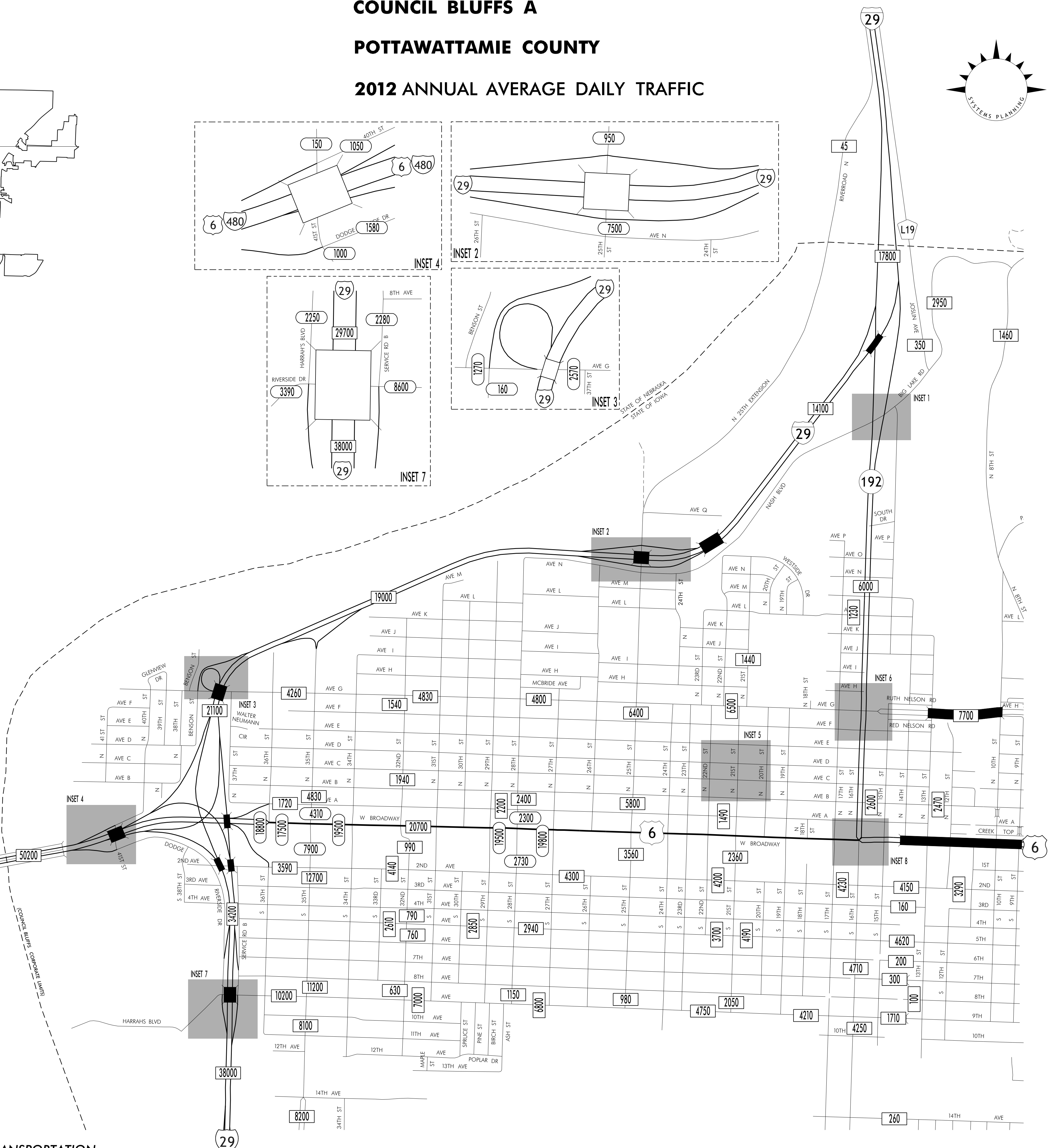

TRAFFIC FLOW MAP OF
COUNCIL BLUFFS B
POTTAWATTAMIE COUNTY
2012 ANNUAL AVERAGE DAILY TRAFFIC

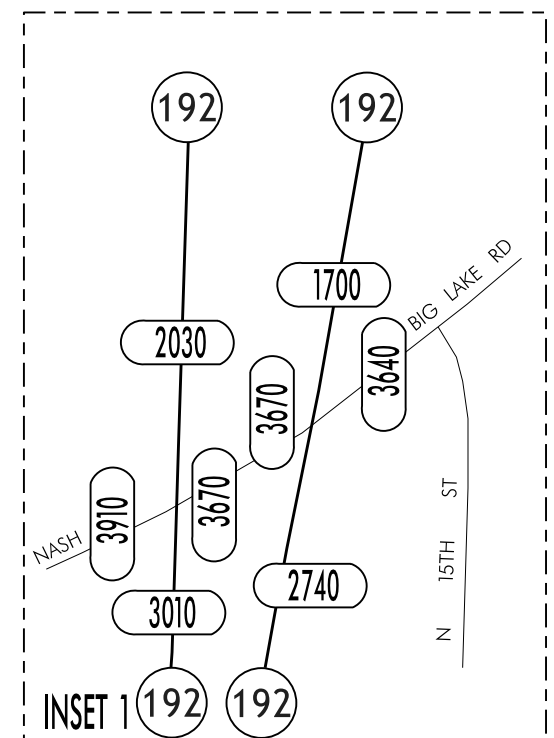

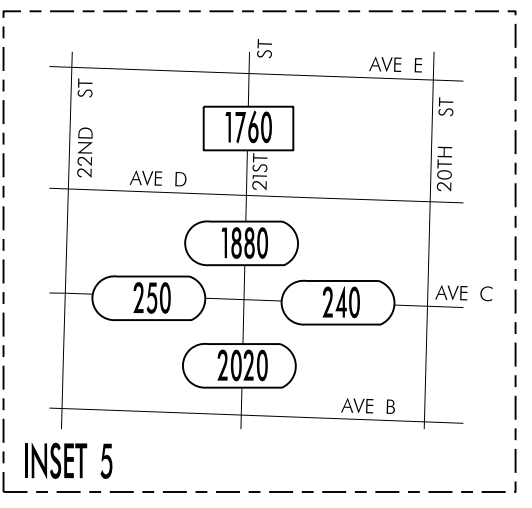
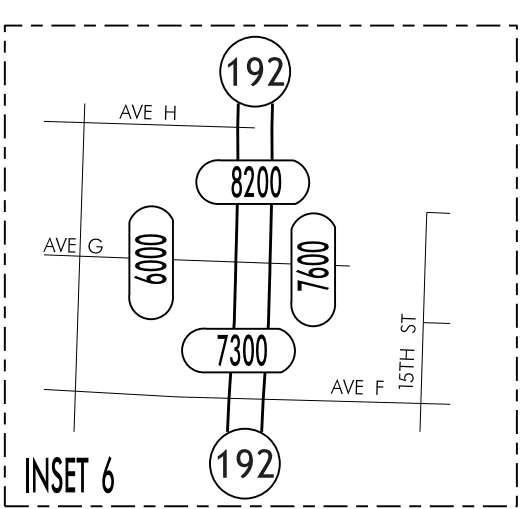
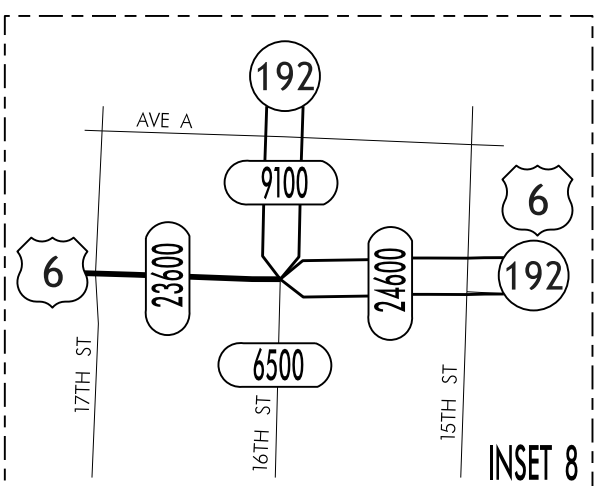
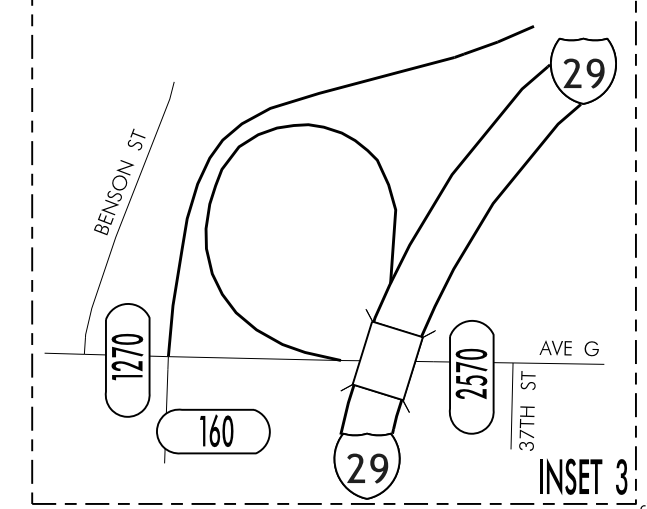
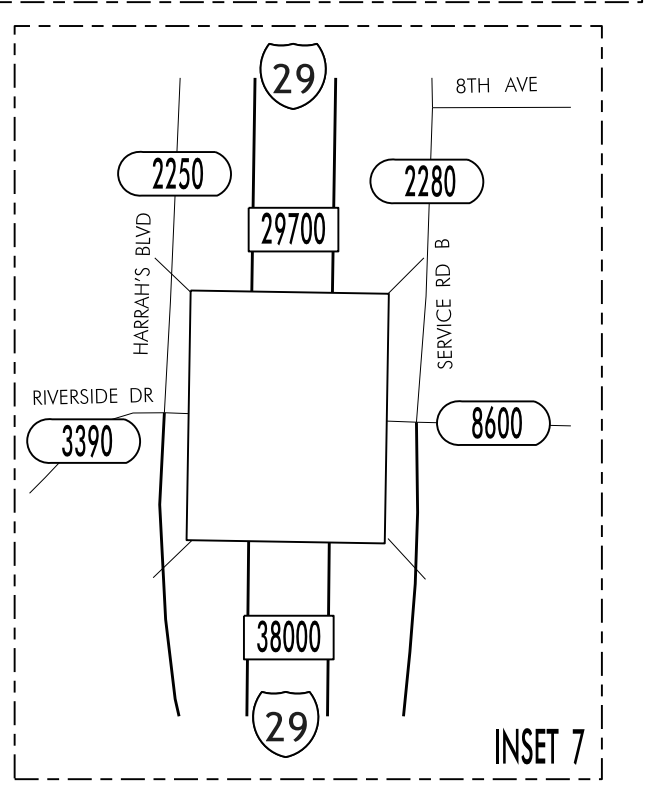
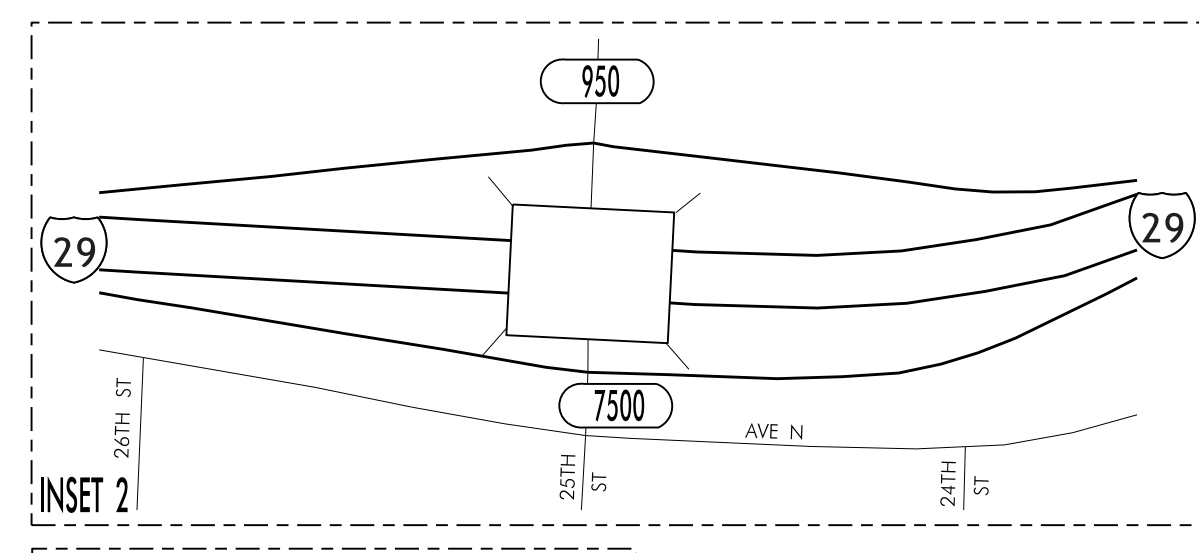
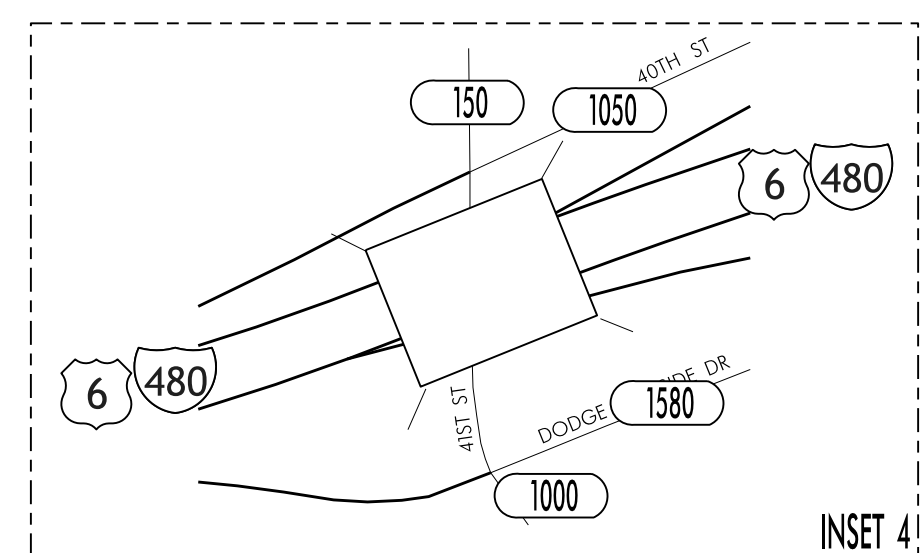
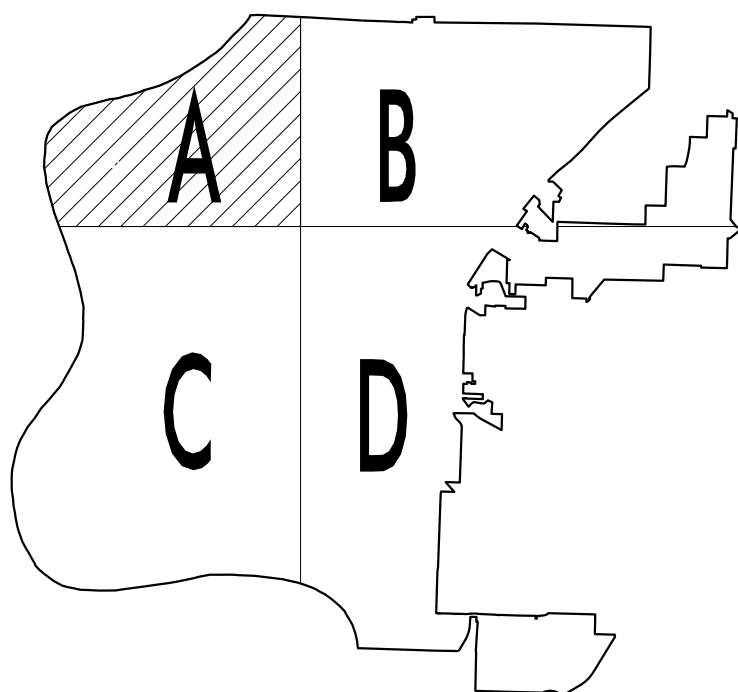
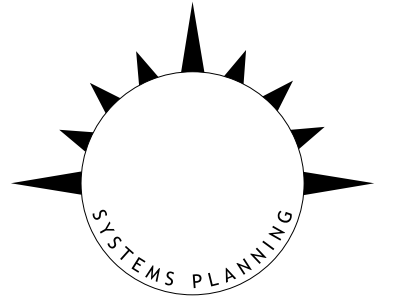
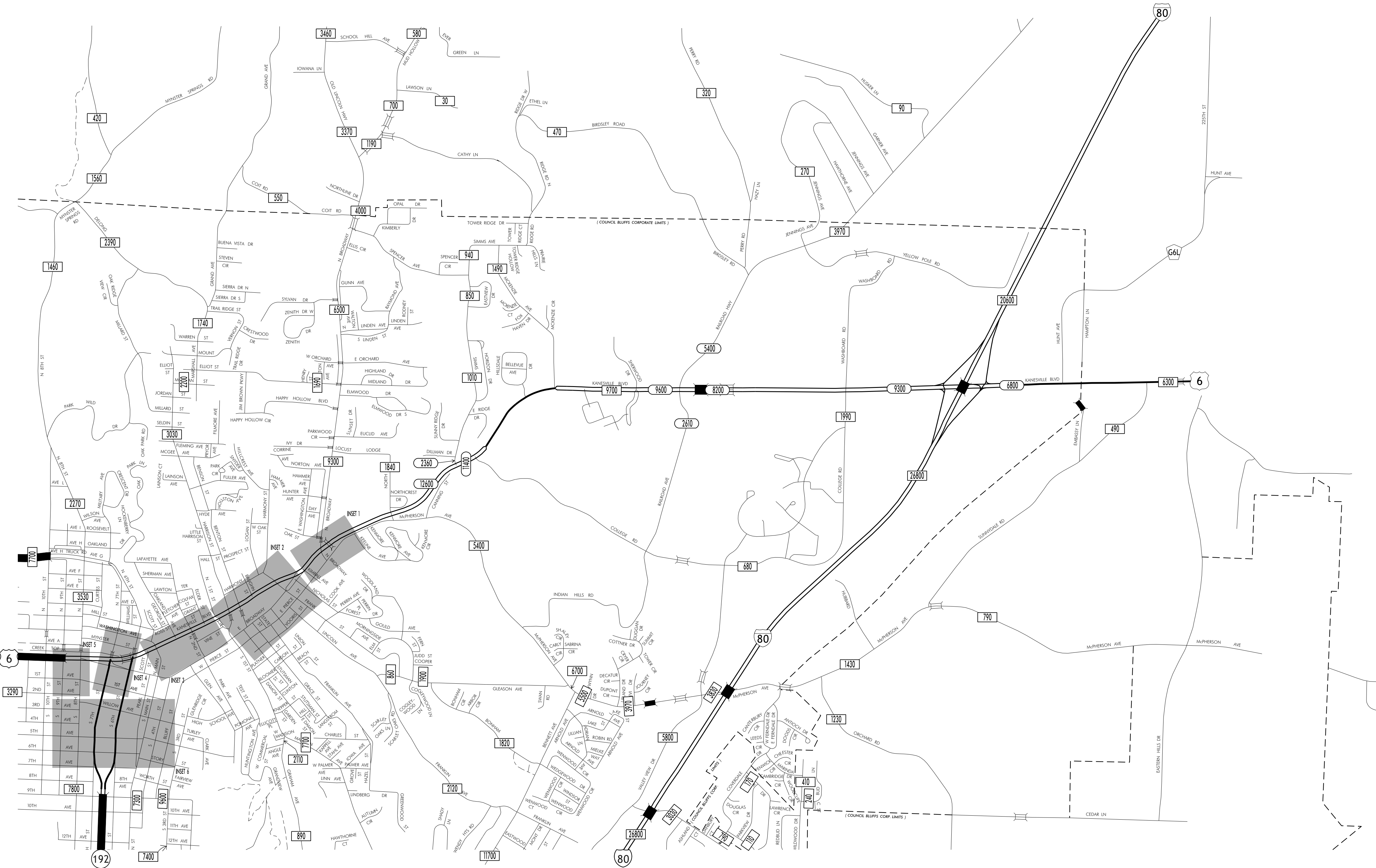
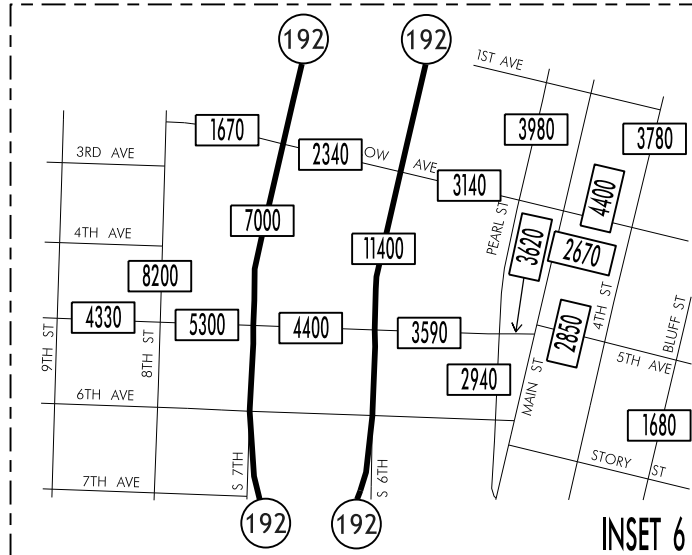
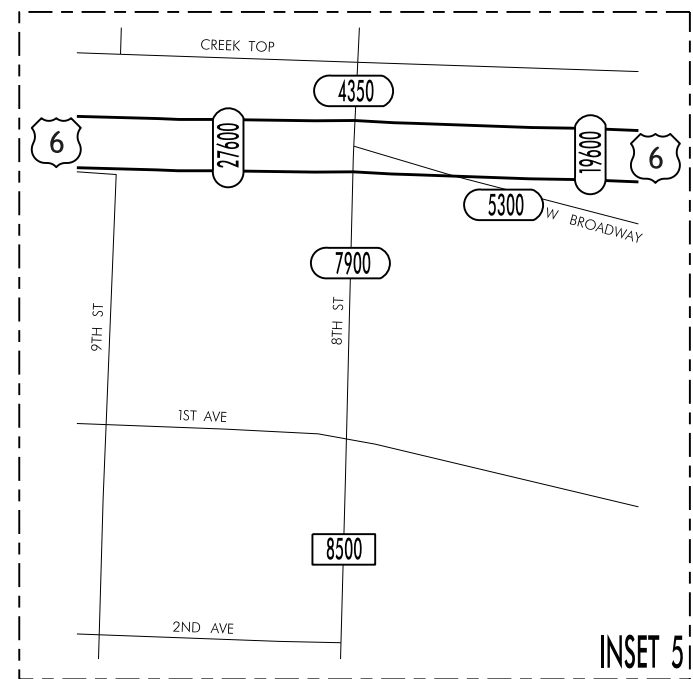
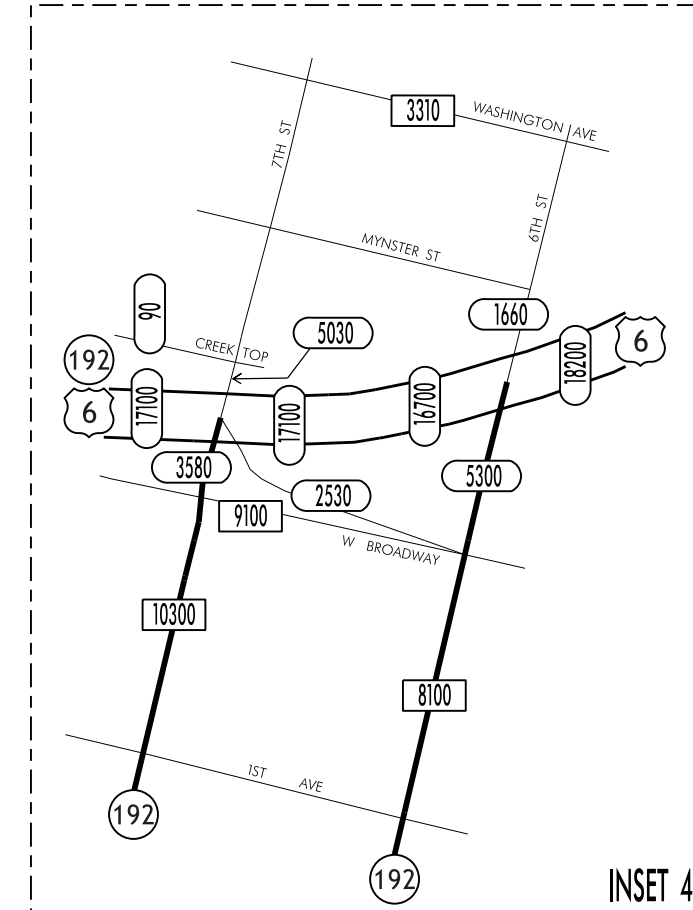
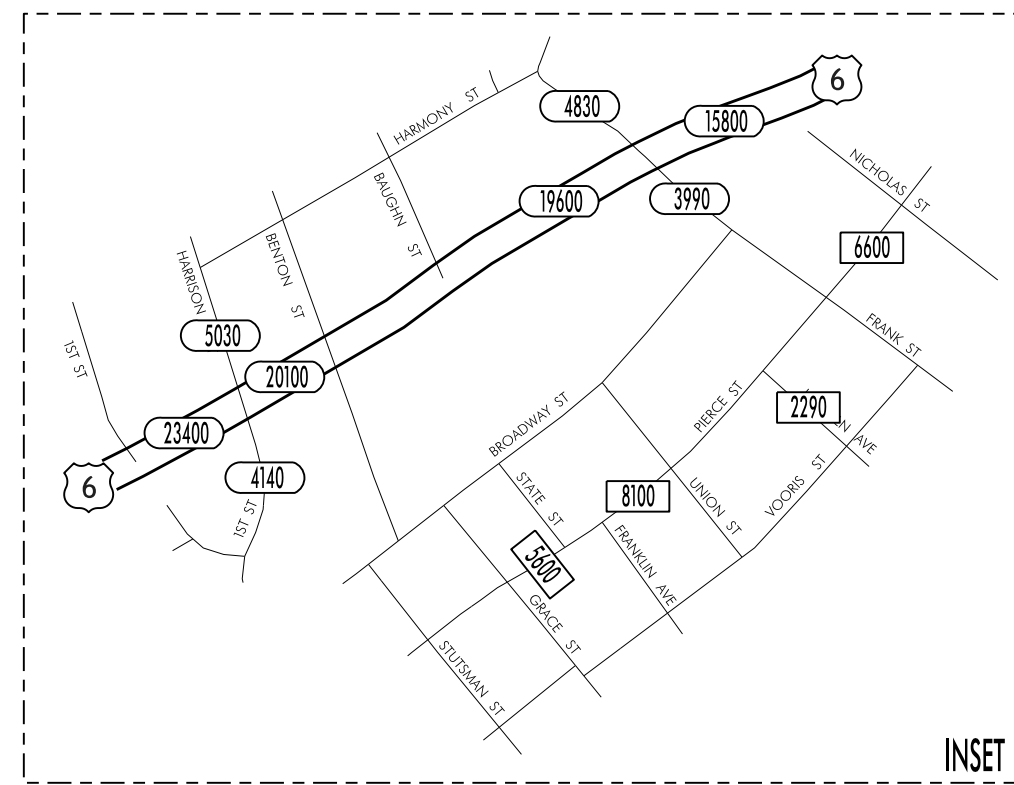
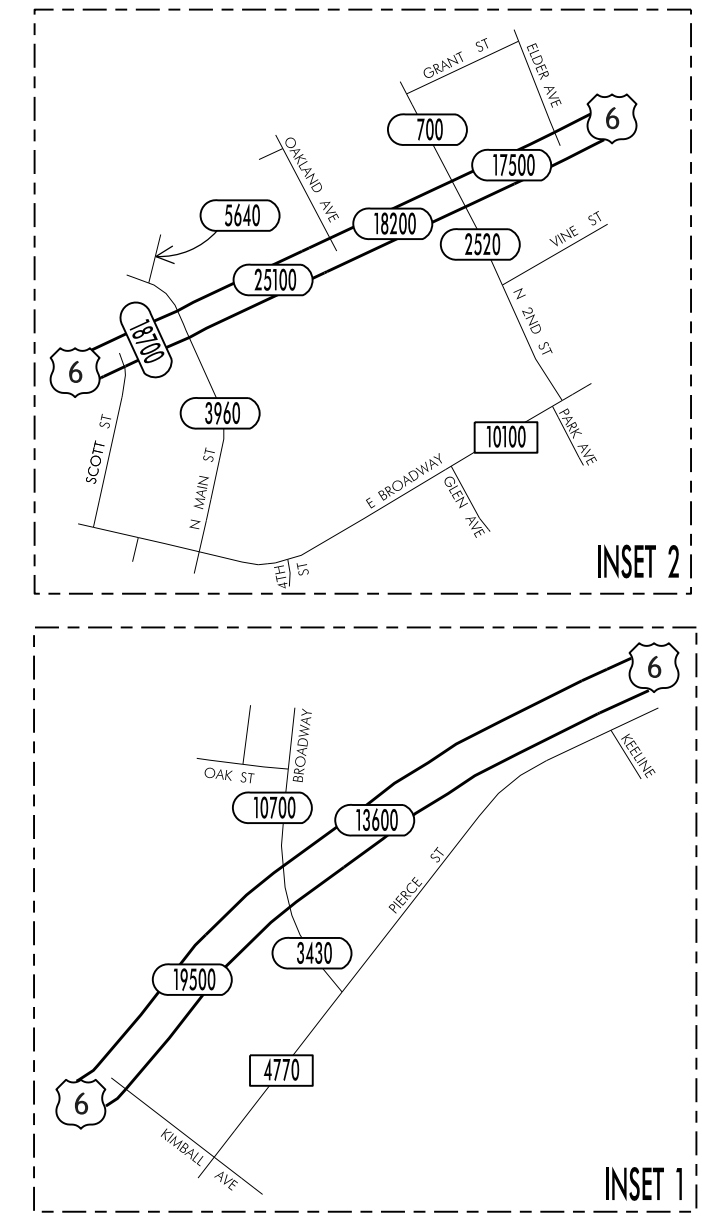
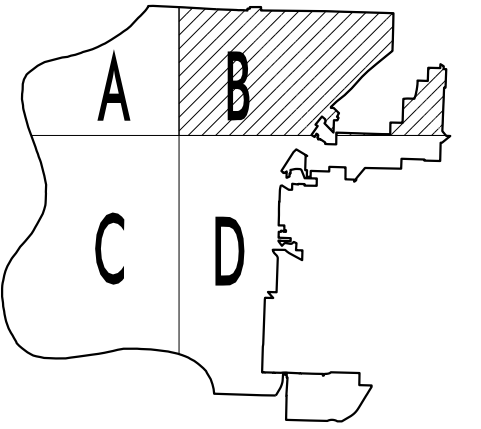
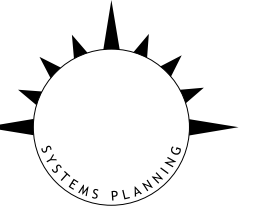
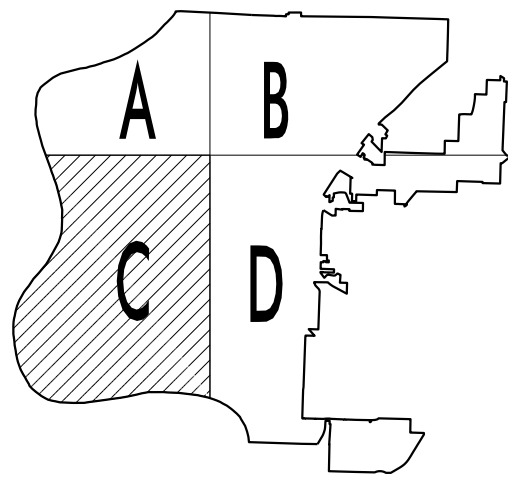

TRAFFIC FLOW MAP OF
COUNCIL BLUFFS C
POTTAWATTAMIE COUNTY
2012 ANNUAL AVERAGE DAILY TRAFFIC

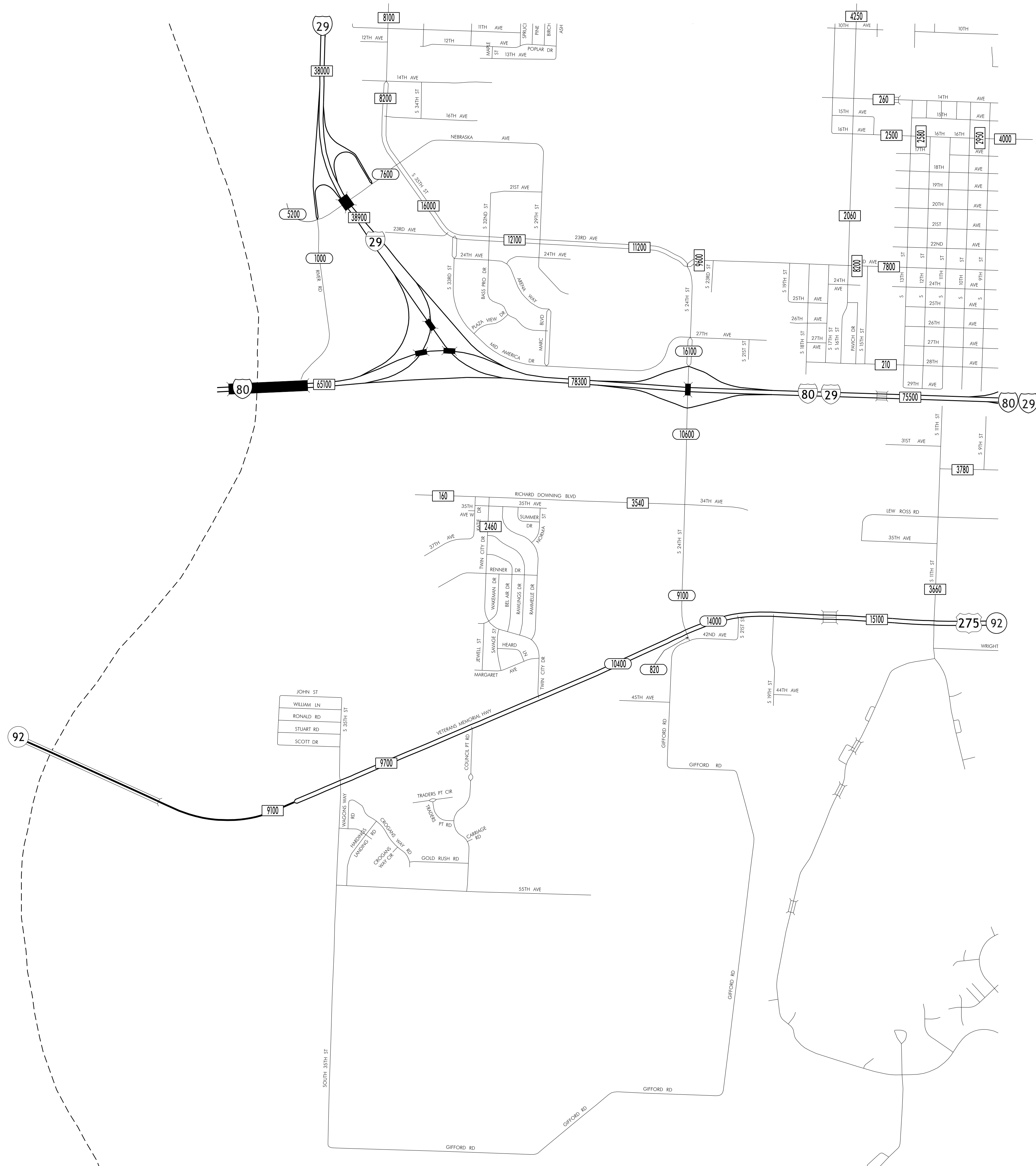
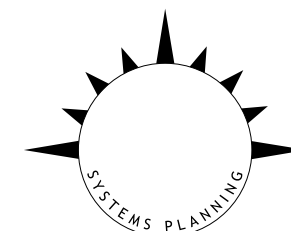

JOHN ST
WILLIAM LN
RONALD RD
STUART RD
SCOTT DR

STATE OF IOWA
 STATE OF NEBRASKA

[COUNCIL BLUFFS CORPORATE LIMITS]

LEGEND

RECORDED ONLY
 MANUAL COUNT

TRAFFIC FLOW MAP OF
COUNCIL BLUFFS D
POTTAWATTAMIE COUNTY
2012 ANNUAL AVERAGE DAILY TRAFFIC

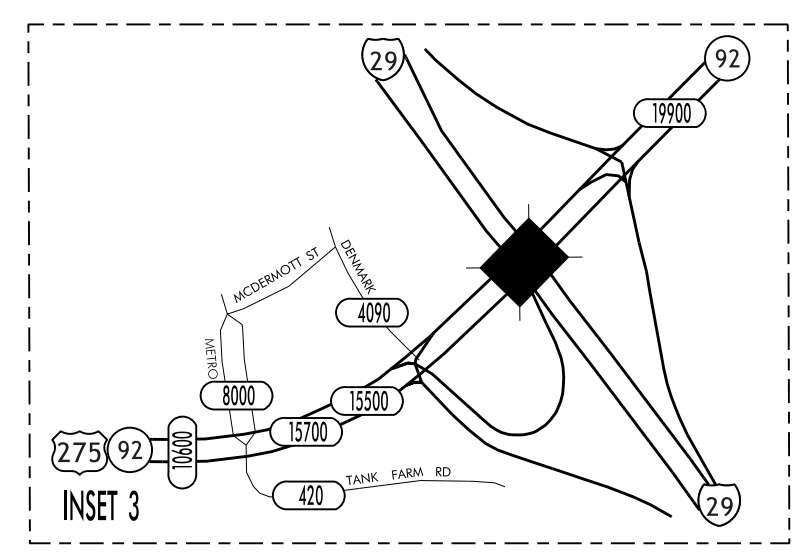
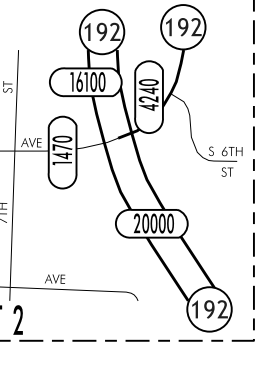
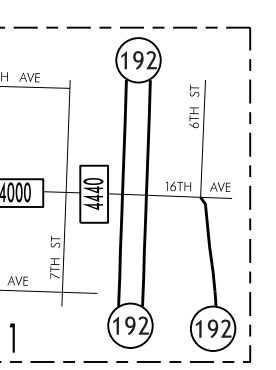
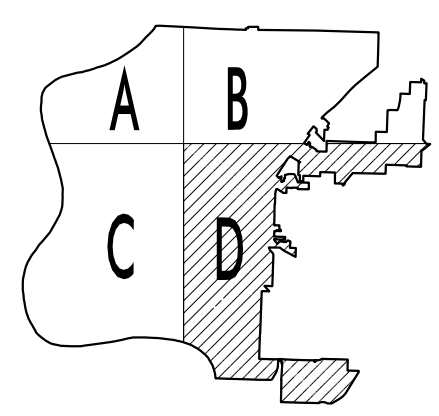
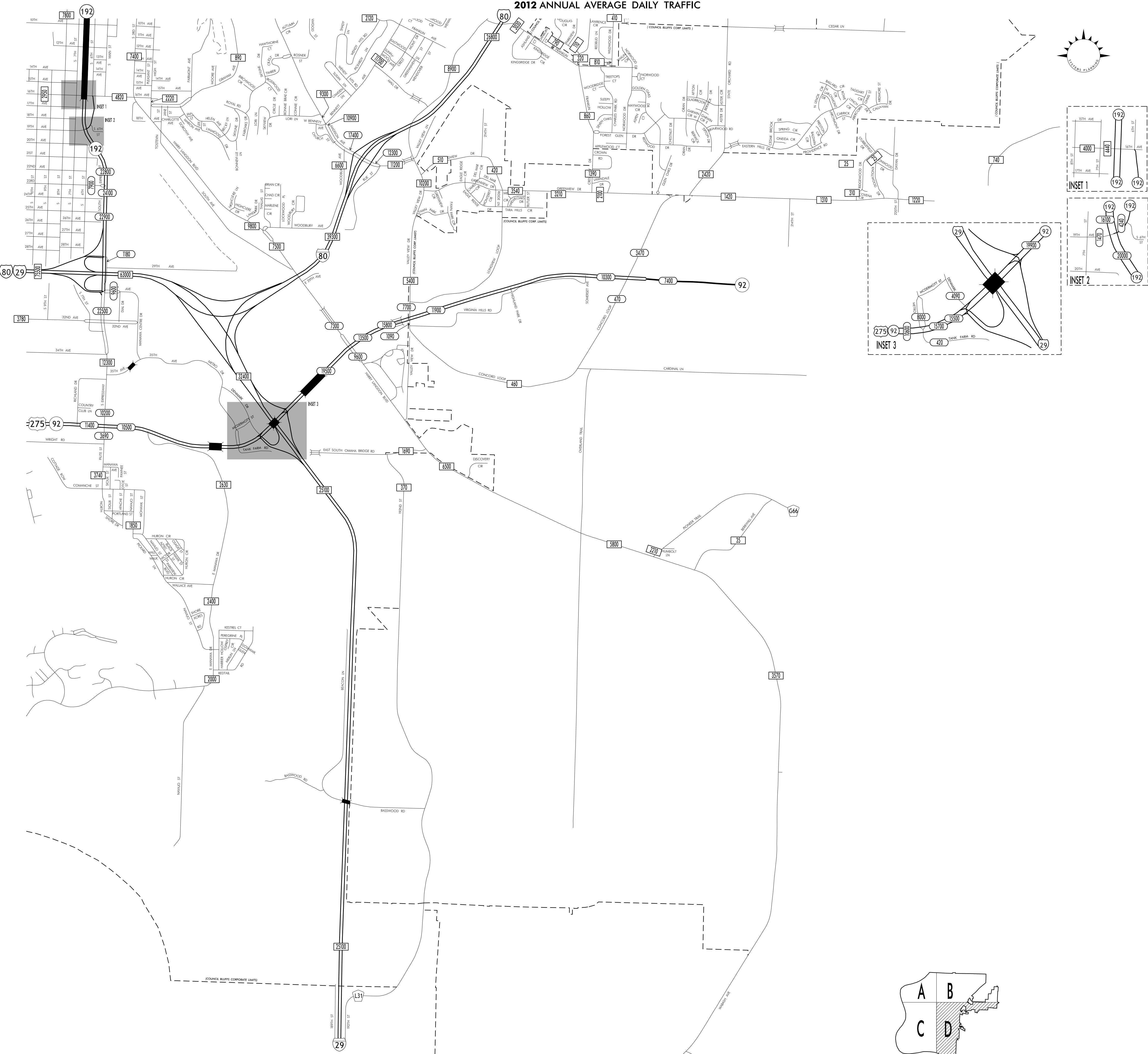
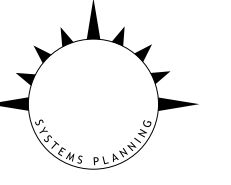

LEGEND
 RECORDER ONLY
 MANUAL COUNT