

TRAFFIC FLOW MAP OF  
**MASON CITY A**  
**CERRO GORDO COUNTY**  
**2017 ANNUAL AVERAGE DAILY TRAFFIC**

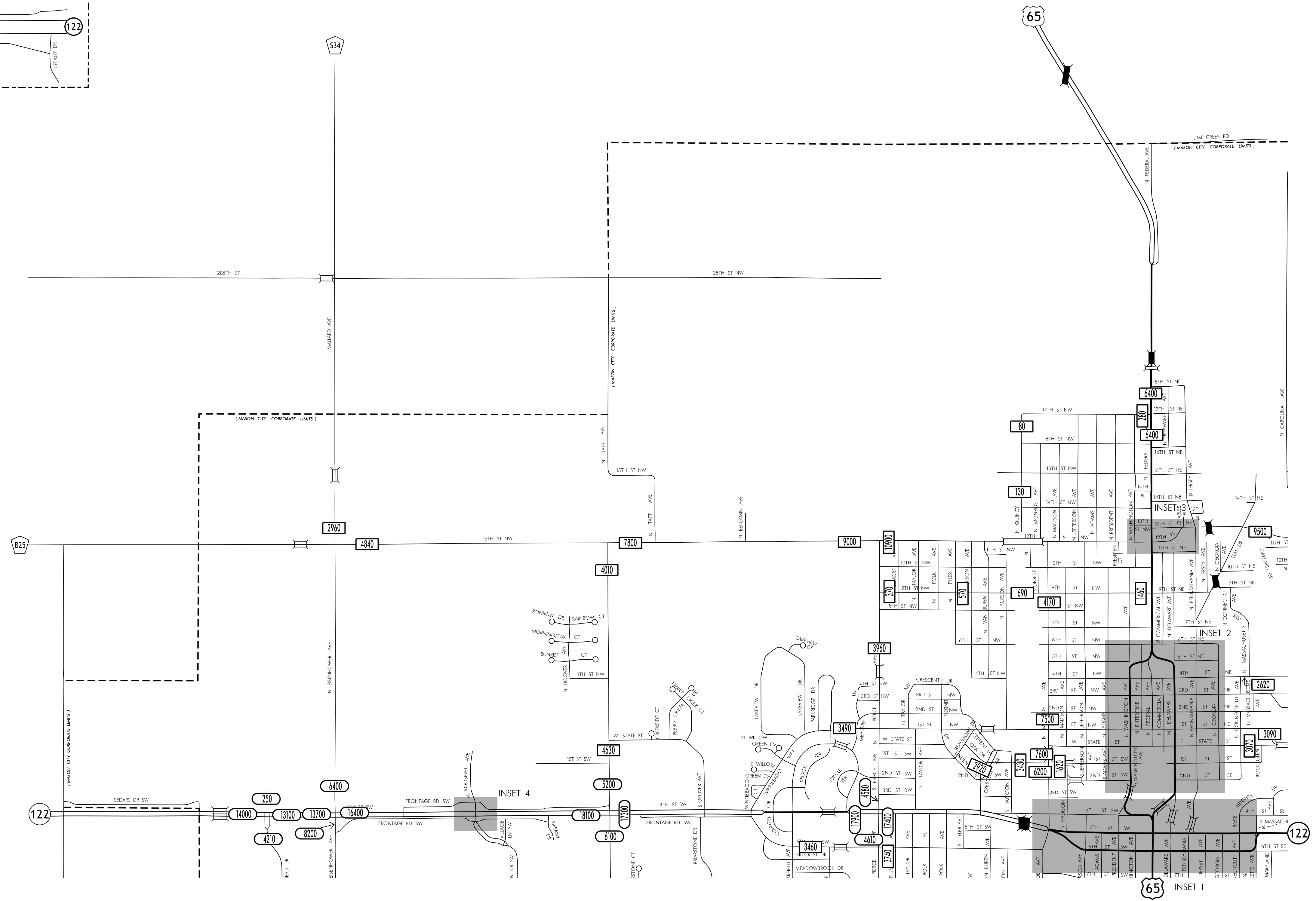

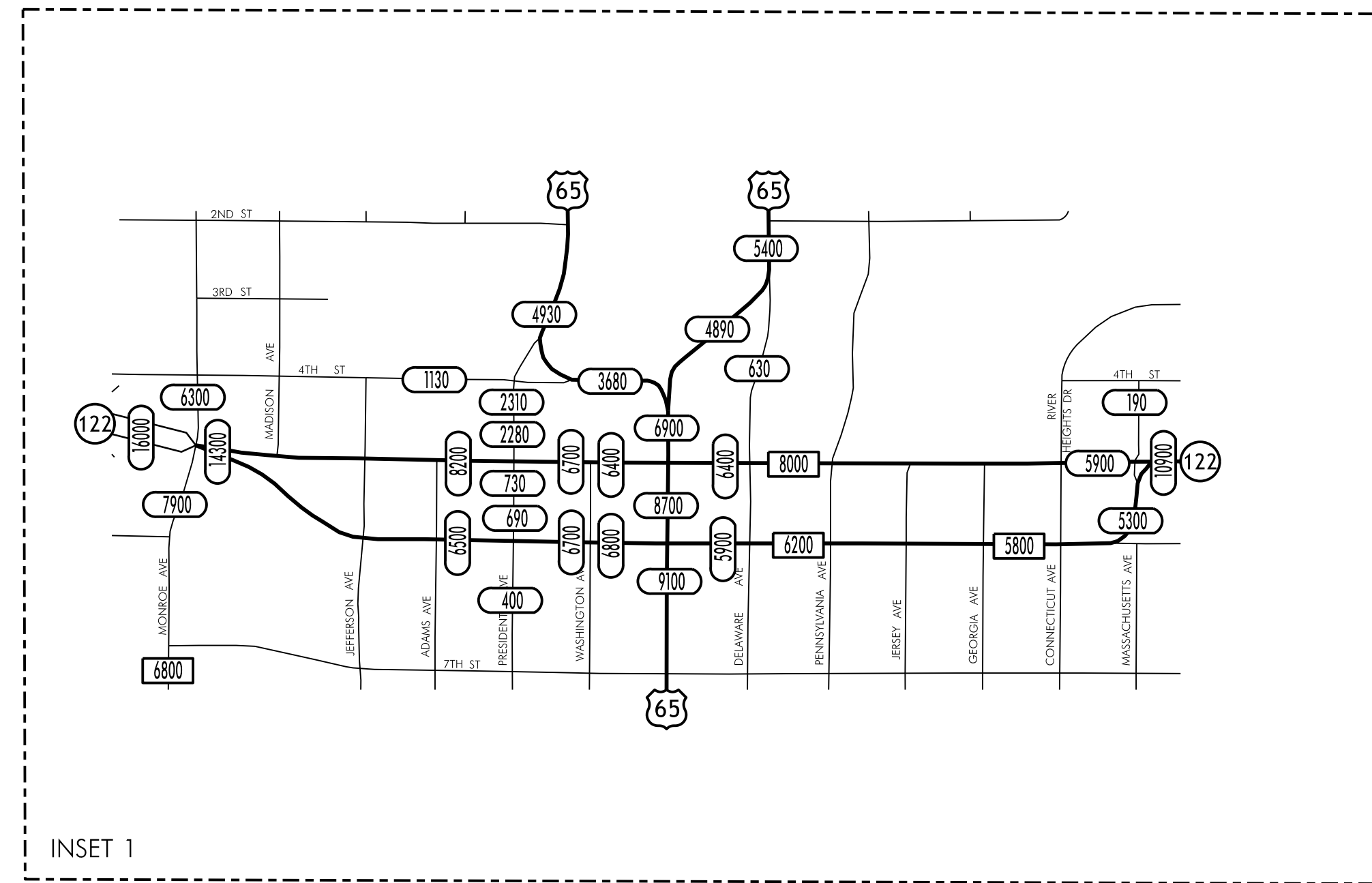
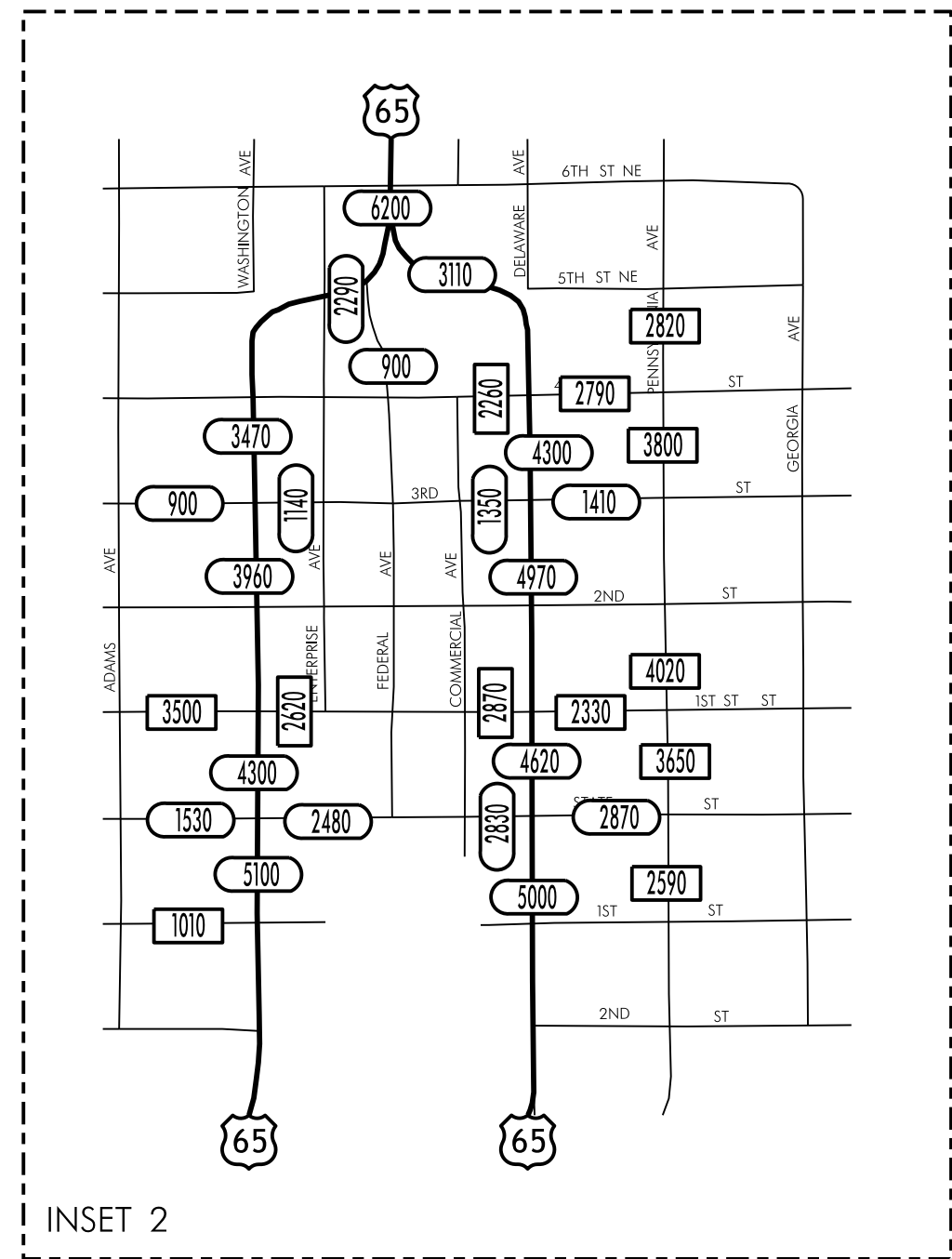
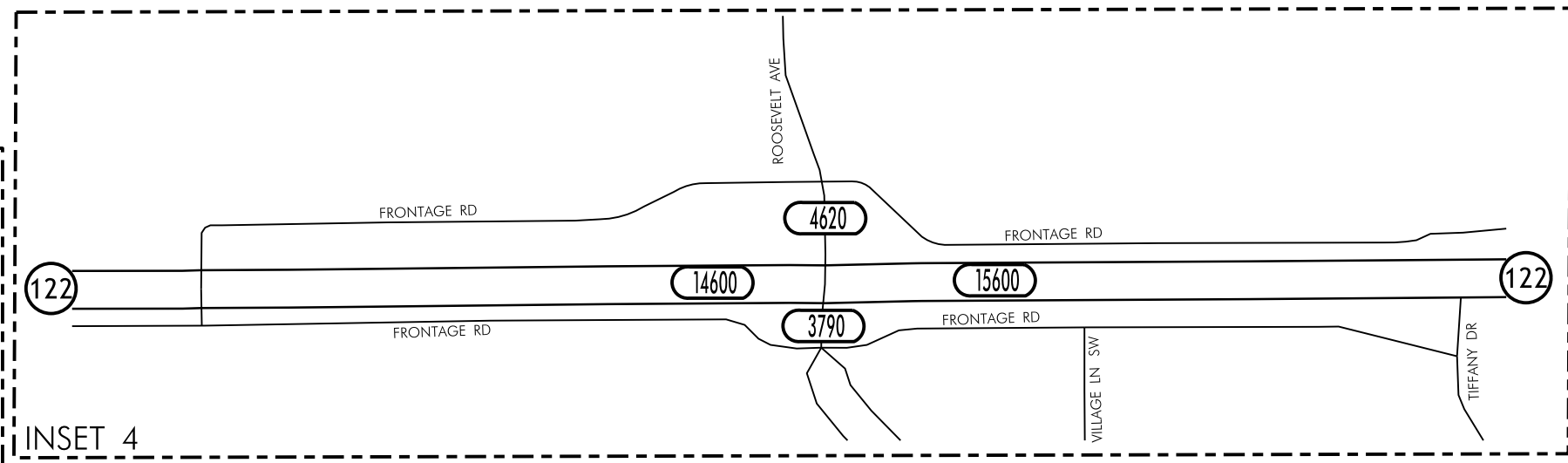
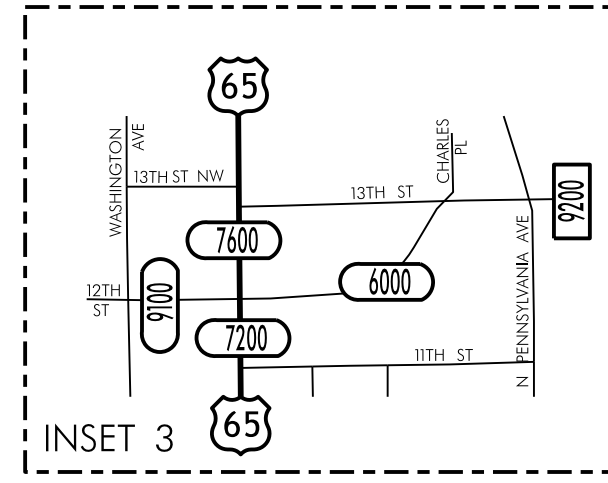
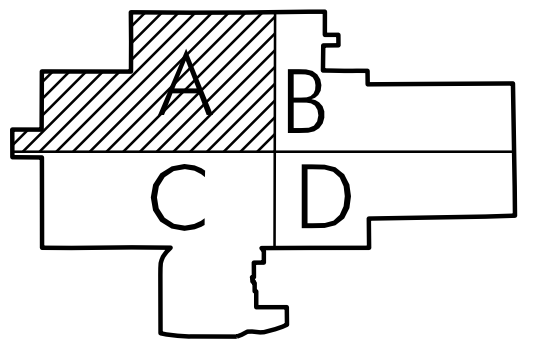
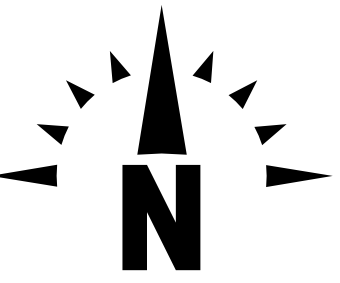
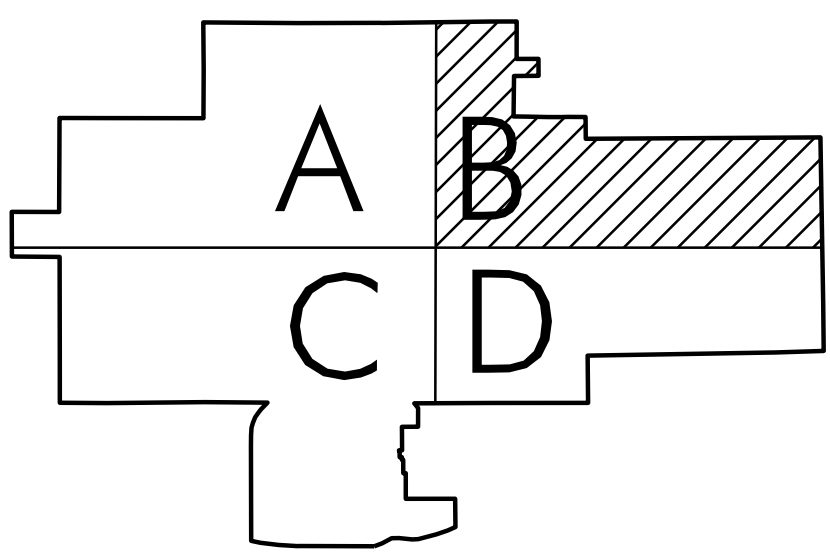
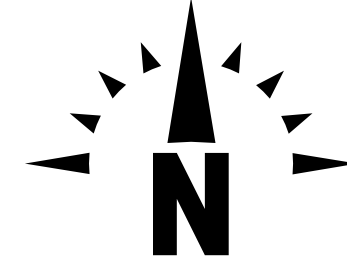

TRAFFIC FLOW MAP OF

**MASON CITY B**

**CERRO GORDO COUNTY**

**2017 ANNUAL AVERAGE DAILY TRAFFIC**

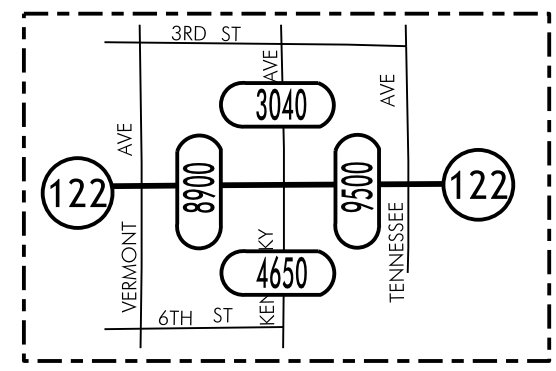
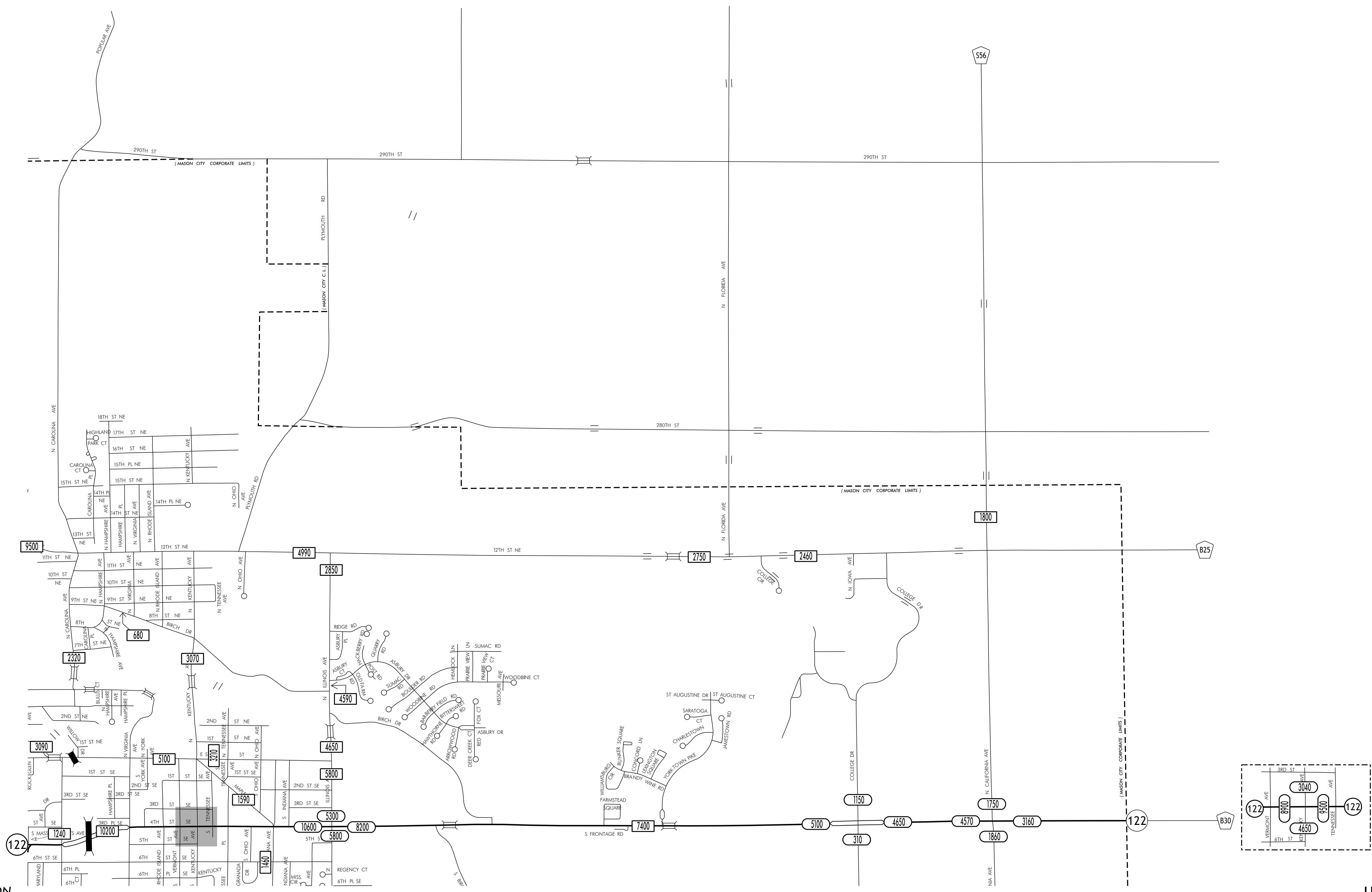

TRAFFIC FLOW MAP OF  
**MASON CITY C**  
**CERRO GORDO COUNTY**  
**2017 ANNUAL AVERAGE DAILY TRAFFIC**

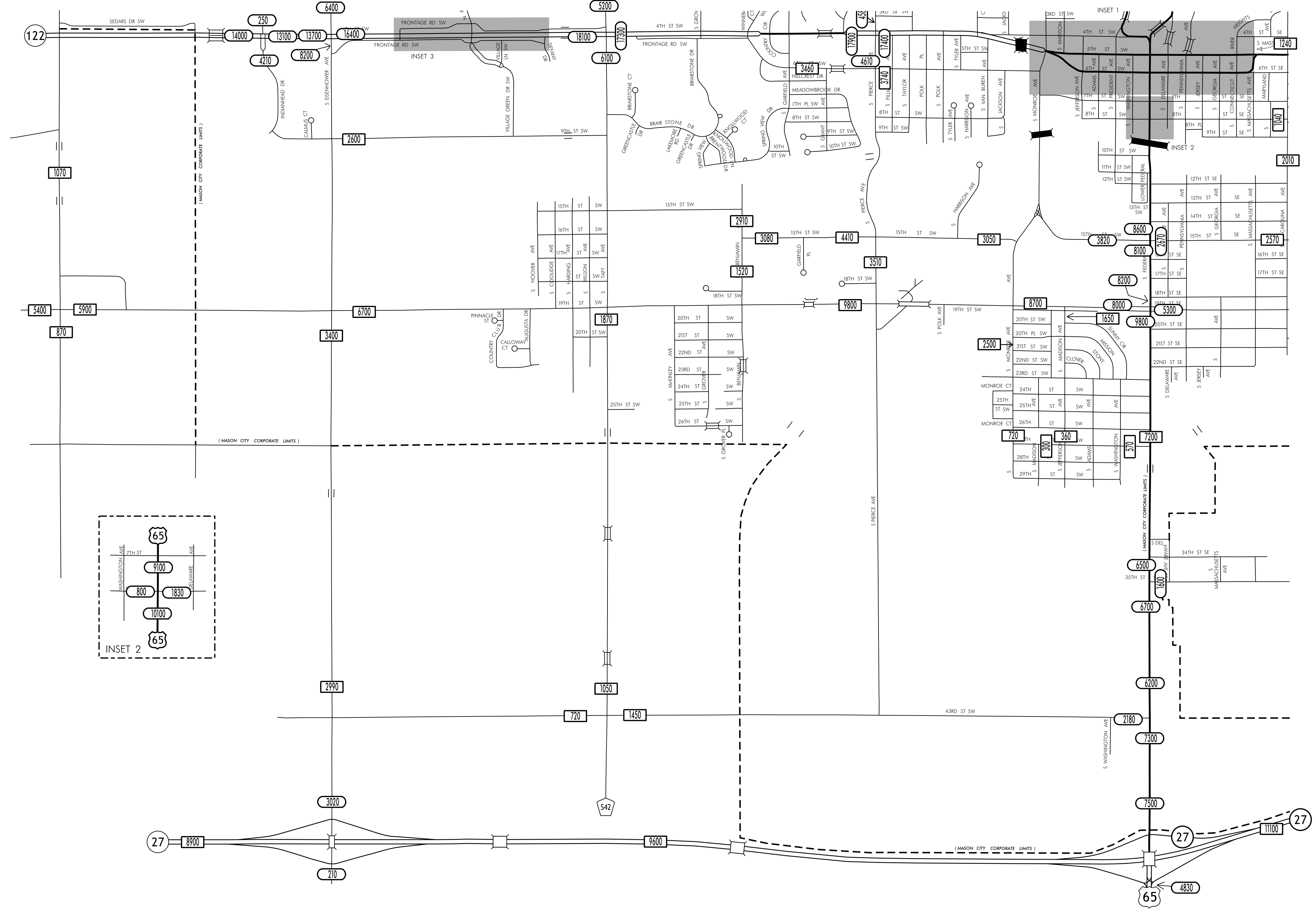
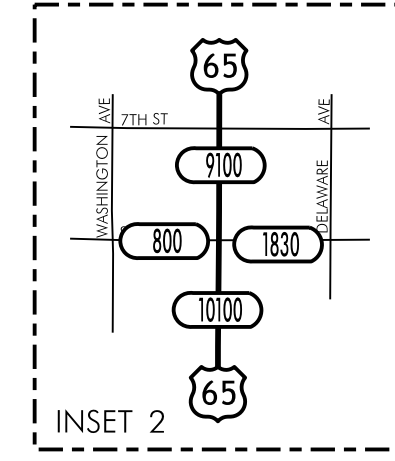
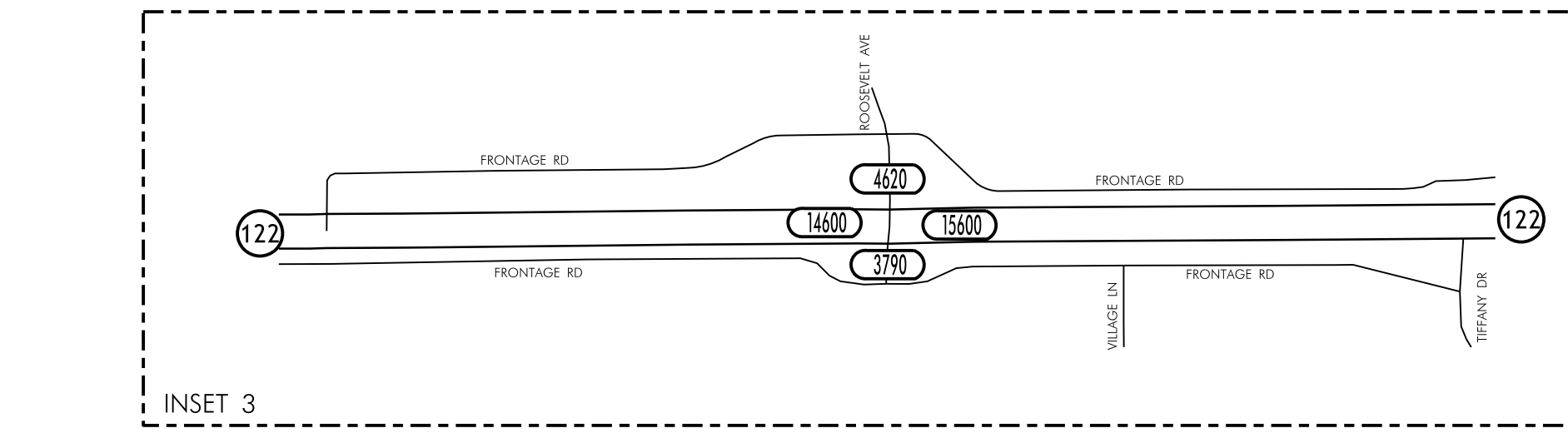
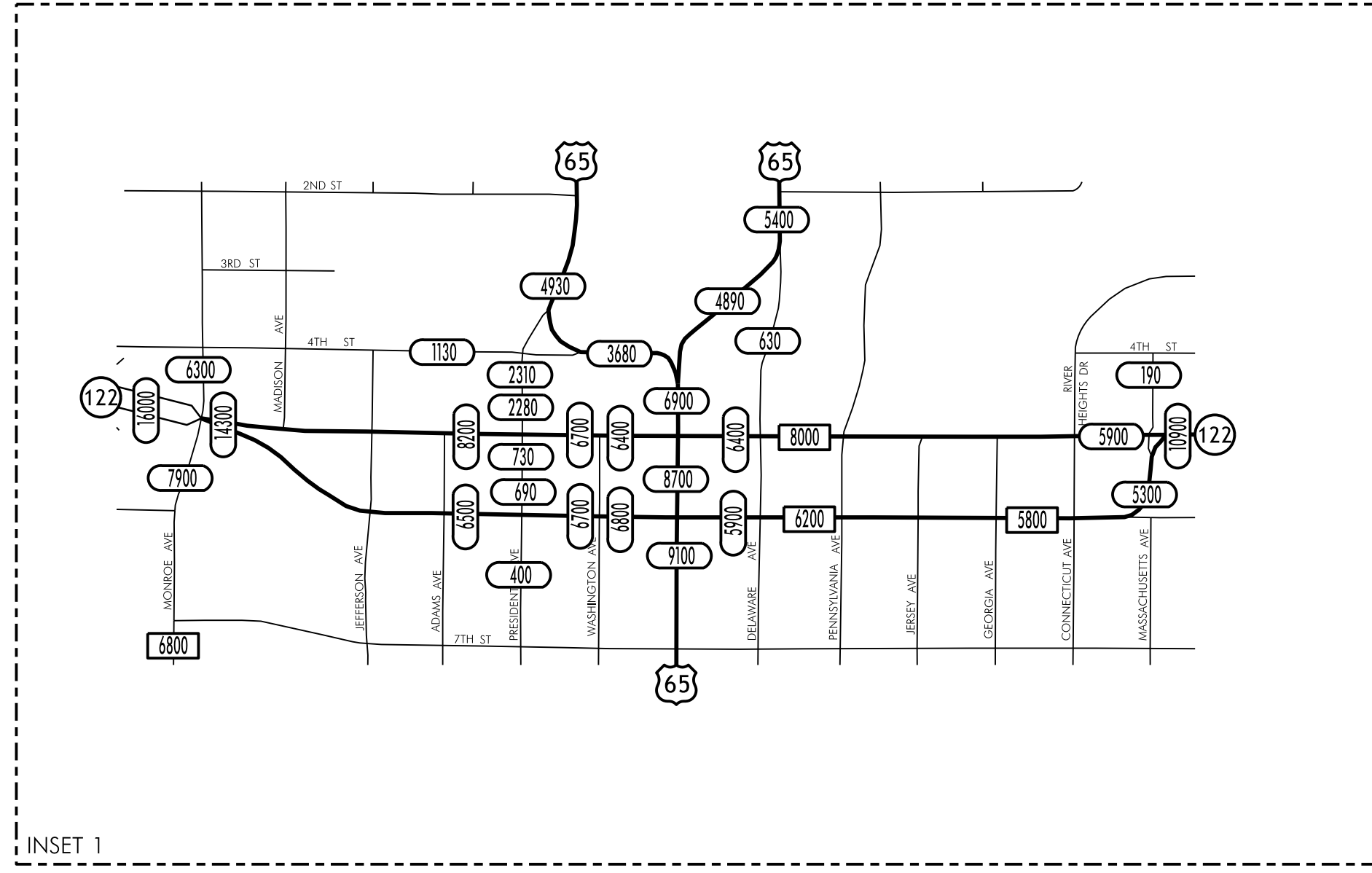
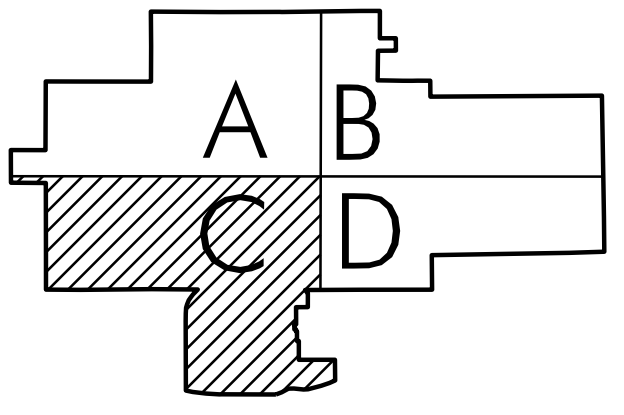
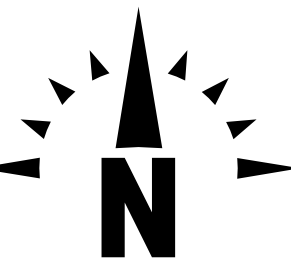

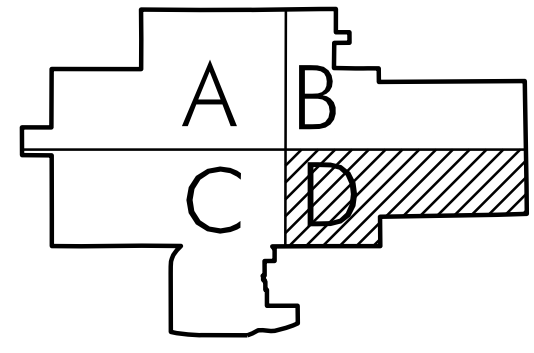

TRAFFIC FLOW MAP OF  
**MASON CITY D**  
**CERRO GORDO COUNTY**  
**2017 ANNUAL AVERAGE DAILY TRAFFIC**

