

TRAFFIC FLOW MAP OF  
**MUSCATINE A**  
**MUSCATINE COUNTY**  
**2022 ANNUAL AVERAGE DAILY TRAFFIC**

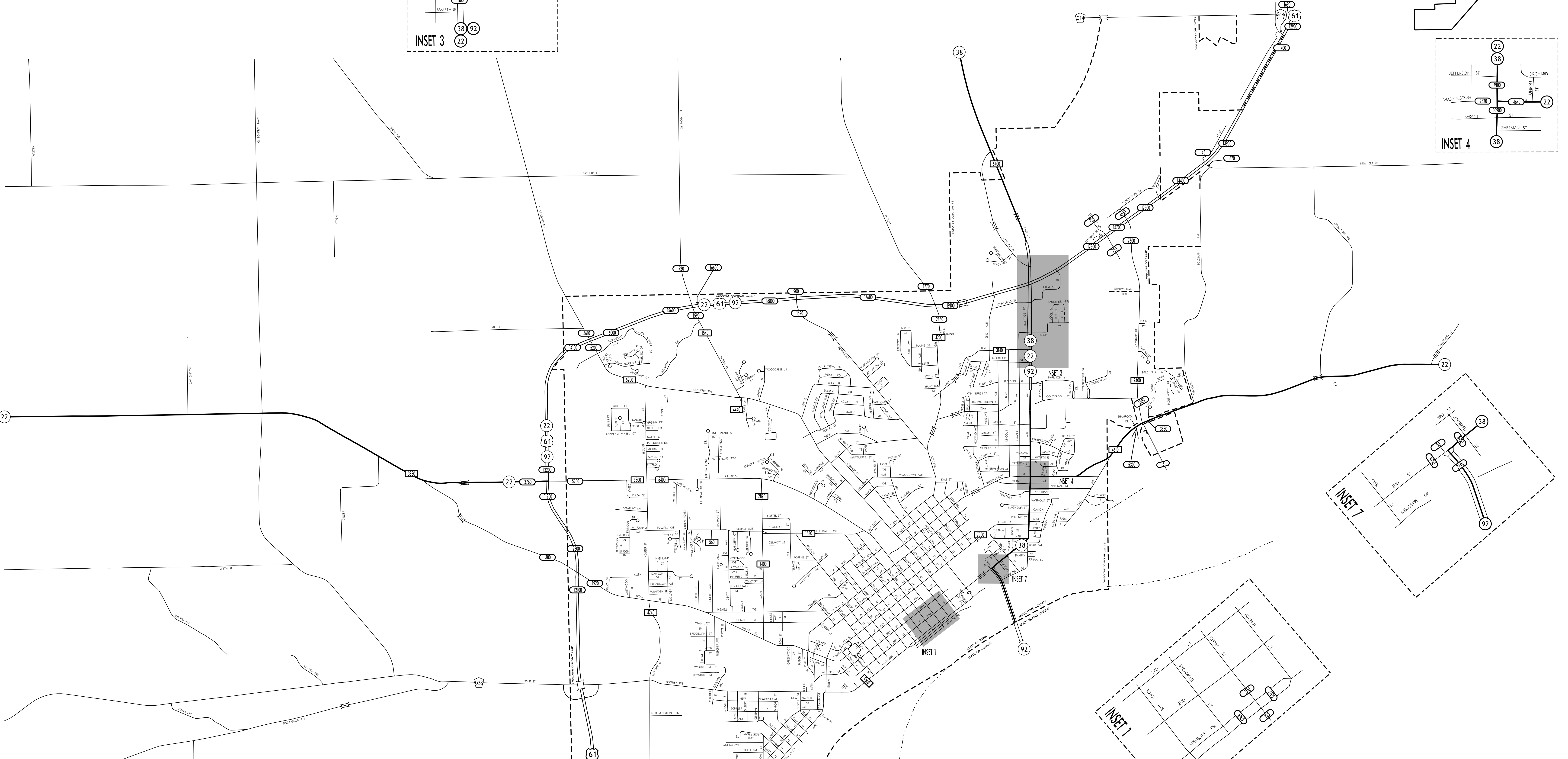

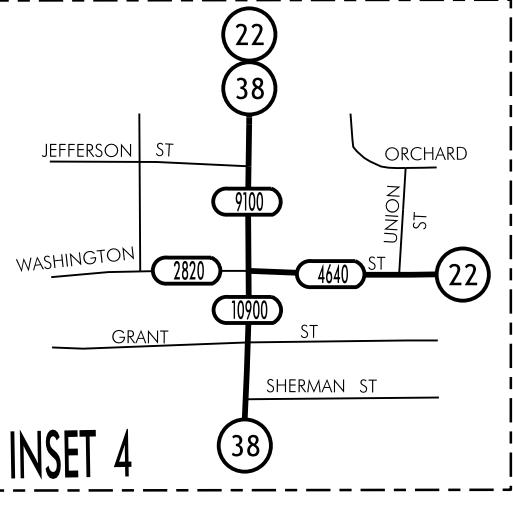

TRAFFIC FLOW MAP OF  
**MUSCATINE B**  
**MUSCATINE COUNTY**  
2022 ANNUAL AVERAGE DAILY TRAFFIC

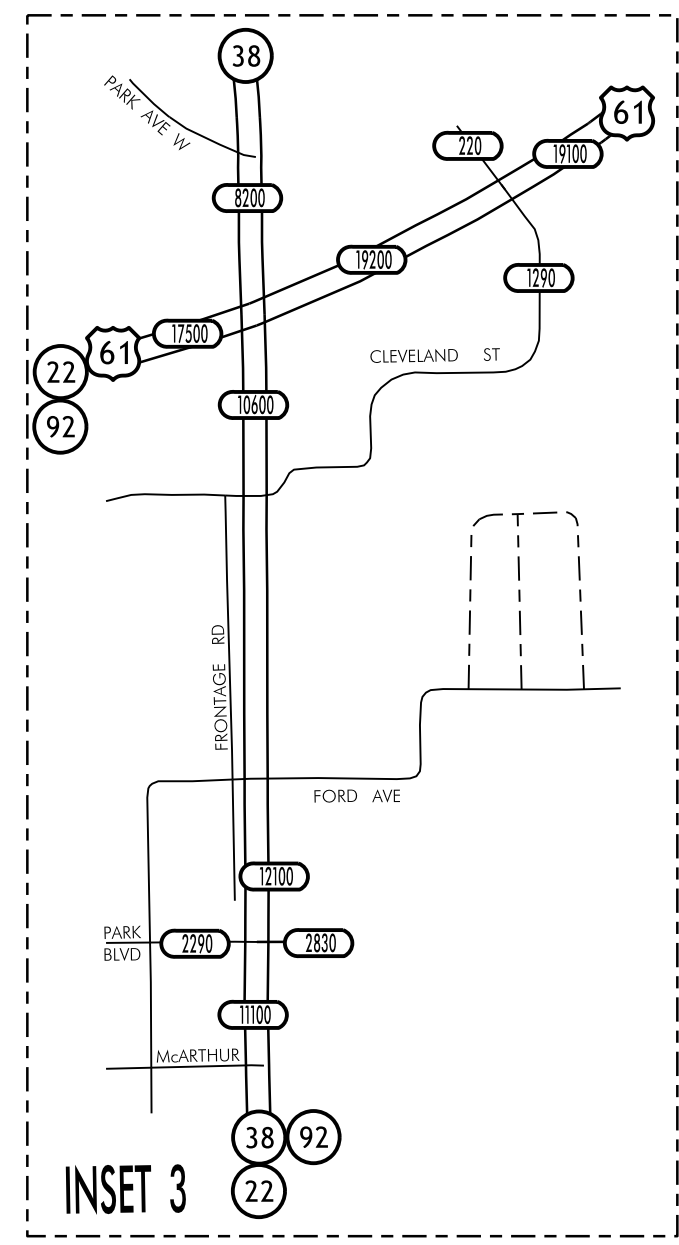
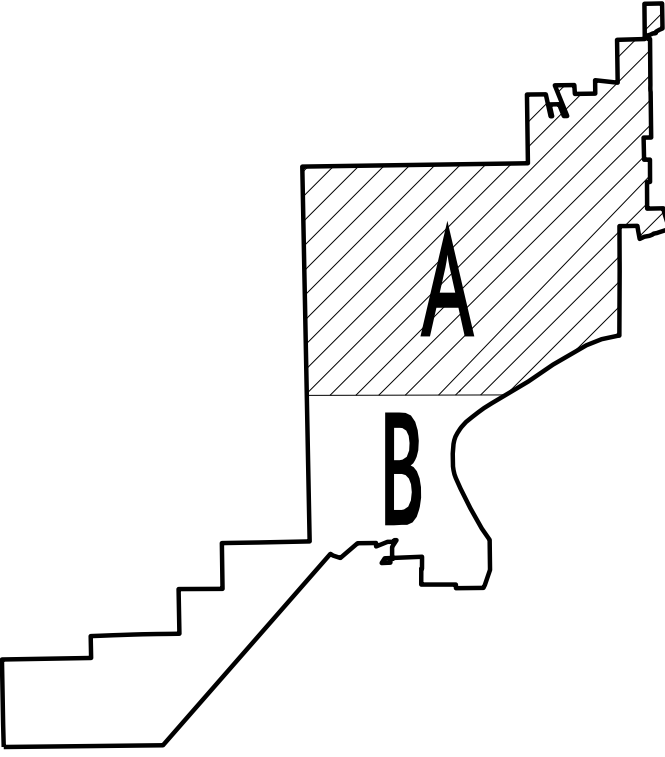
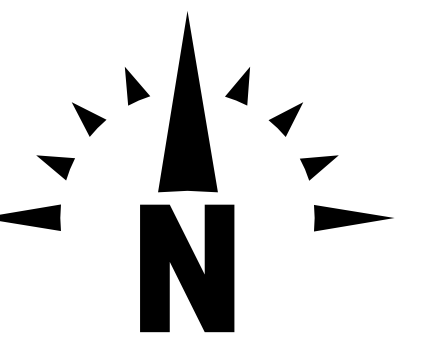
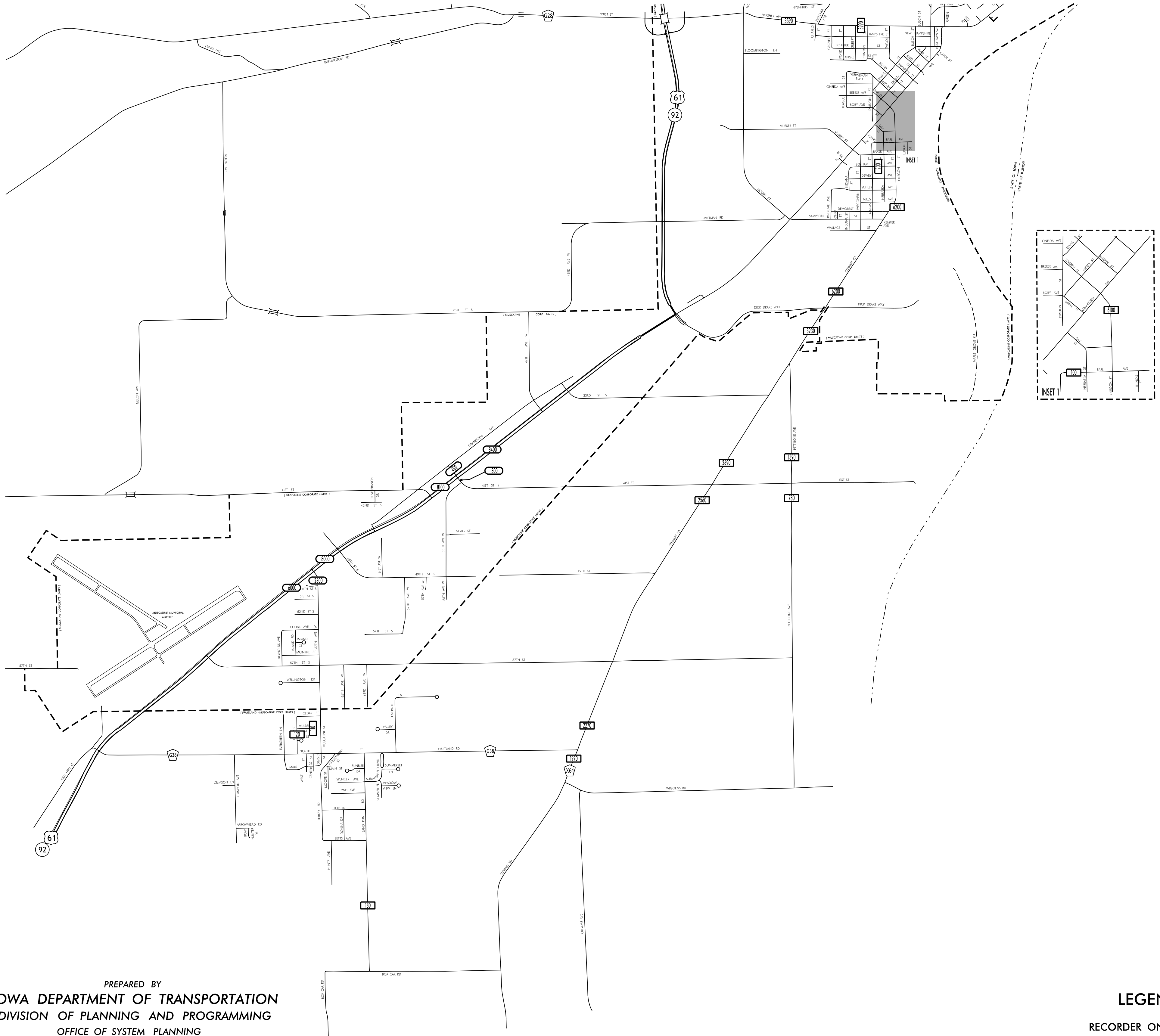
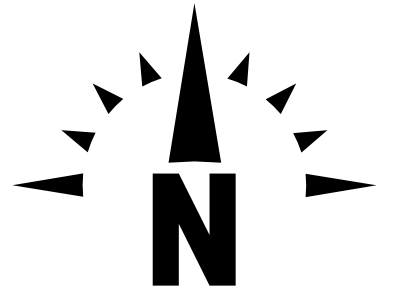
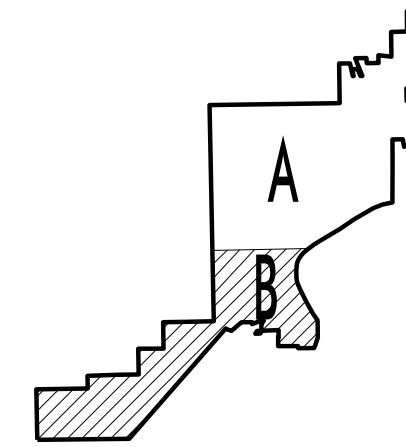

PREPARED BY  
IOWA DEPARTMENT OF TRANSPORTATION  
DIVISION OF PLANNING AND PROGRAMMING  
OFFICE OF SYSTEM PLANNING  
PHONE (515) 239-1289

**LEGEND**  
RECORDER ONLY   
MANUAL COUNT